



The United Nations
University

WIDER

World Institute for Development Economics Research

Research for Action

**Internationalization of
Finnish Firms and their
Response to Global
Challenges**

Reijo Luostarinen

Research for Action

UNU World Institute for
Development Economics Research
(UNU/WIDER)

Research for Action

**Internationalization of Finnish Firms
and their Response to Global
Challenges**

Reijo Luostarinen

UNU World Institute for Development Economics Research (UNU/WIDER)
A research and training centre of the United Nations University

The Board of UNU/WIDER

Philip Ndegwa
Sylvia Ostry
Maria de Lourdes Pintasilgo, Chairperson
Antti Tanskanen
Ruben Yevstigneyev
Masaru Yoshitomi

Ex Officio

Heitor Gurgulino de Souza, Rector of UNU
Mihály Simai, Director of UNU/WIDER

UNU World Institute for Development Economics Research (UNU/WIDER) was established by the United Nations University as its first research and training centre and started work in Helsinki, Finland, in 1985. The principal purpose of the Institute is policy-oriented research on the main strategic issues of development and international cooperation, as well as on the interaction between domestic and global changes. Its work is carried out by staff researchers and visiting scholars in Helsinki and through networks of collaborating institutions and scholars around the world.

Copyright © UNU World Institute for Development Economics Research (UNU/WIDER)

Printed at Forssa Printing House Ltd, 1994

The views expressed in this publication are those of the author(s). Publication does not imply endorsement by the Institute or the United Nations University of any of the views expressed.

ISBN 952-9520-20-4

CONTENTS

	LIST OF TABLES	iv
	LIST OF FIGURES	v
	PREFACE	vii
I	INTRODUCTION	1
II	INTERNATIONALIZATION OF FINNISH FIRMS BASED ON A SMALL AND OPEN ECONOMY (SMOPEC)	3
	2.1 Internationalization at country, industry and firm levels	3
	2.2 Factors explaining internationalization	6
	2.3 Internationalization as a holistic stage process	10
	2.4 Criticism on the stage pattern of internationalization	21
	2.5 Explanatory theories for stage development	22
	2.6 Factors explaining success in internationalization	25
	2.7 Job and wealth creation through internationalization	31
III	THE ROLE OF FINNISH GOVERNMENT IN THE INTERNATIONALIZATION PROCESS	32
IV	RELEVANCE OF FINNISH EXPERIENCE FOR OTHER COUNTRIES	37
	4.1 SMOPECs	37
	4.2 Economies in transition	38
	4.3 Developing countries	38
V	INTERNATIONALIZATION OF FINNISH FIRMS AND DEVELOPING COUNTRIES	40
VI	FUTURE CHALLENGES FOR INTERNATIONALIZING FINNISH FIRMS	42
	REFERENCES	45
	APPENDIX	48

LIST OF TABLES

	page
Text tables	
Table 1 Internationalization order of different fields of business in Finnish economy	4
Table 2 Internationalization process of Finnish industries	5
Table 3 International stages at the company level	6
Table 4 Major components of internationalization strategy	12
Table 5 The chronological order of introduction of different international business sales objects in 998 Finnish companies	14
Table 6 The order of utilization of different operation modes in 997 Finnish companies in 1976	14
Table 7 The absolute and relative frequencies of the first foreign entry of 924 Finnish companies by market clusters based on business distance	14
Appendix tables	
Table A1 Order of utilization of inward, outward and cooperation modes of international operations in 586 Finnish industrial companies in 1990	50
Table A2 Changes needed in the planning and promotion of outward international business operations	52
Table A3 Future directions of the planning and promotional measures for internationalization	52
Table A4 Internationalization promotion covers both industrial and service companies	52

LIST OF FIGURES

	page
Text figures	
Figure 1 Powerfield for the internationalization of Finnish firms	7
Figure 2 Hypothetical company profiles based on different dimensions of internationalization	13
Figure 3 Internationalization pattern of the firm as a sum of target country patterns	15
Figure 4 Combining the dynamic product, operation and market patterns into a holistic POM-pattern with different stages	16
Figure 5 Mainstream models of the internationalization process of firms	17
Figure 6 Stages of the holistic internationalization process of a firm based on the operation mode dimension	19
Figure 7 Inward-outward relationships divided into direct and indirect categories	20
Figure 8 Framework for the role of organizational learning in the laterally rigid decision-making and action process of a firm	24
Figure 9 MNE- and DCE-areas as business areas to avoid for SMOPEC-firms	25
Figure 10 Competitive edge as a prerequisite for successful internationalization	27
Figure 11 Components of the excellence mix	28
Figure 12 Onion-like profit cycle theory	29

Appendix figures

Figure A1

Factors affecting the internationalization process
of Finnish industrial companies

49

Figure A2

Components and subcomponents of the laterally rigid decision
process towards internationalization

51

PREFACE

Internationalization, globalization, and global competition are reshaping the world economy. These processes are dominated by the main players, which are the North American, German, Japanese, British, and French based transnational corporations. A historically unprecedented economic power is concentrated in these firms. What kinds of possibilities are there for firms from smaller countries? Under what circumstances can they successfully compete in the global battleground? In the search for answers to these questions, the experiences of Finnish firms are indeed very interesting. They may serve as important lessons for smaller countries and especially those which are late-comers.

This booklet is based on the important and interesting lecture of Professor Reijo Luostarinen of the Helsinki School of Economics, in the framework of the Public Forum of UNU/WIDER. It gives an overview on the internationalization process of the Finnish companies: how could they develop global competitiveness, world-wide learning capabilities in the field of managing complex operations, assimilating and developing new technologies, introducing and marketing new products and obtain financial resources for their international operations. In this context, it is also a significant lesson for firms in a similar environment, how did they coordinate domestic activities with international expansion, and combine specialization with diversification. Professor Luostarinen's research work and advice on the globalization process has been, of course, one of the factors which contributed to the success of a number of Finnish firms in their international expansion. It has facilitated not only a better understanding of the process, and its different stages, but it also gave an insight into the functioning of international business.

Mihály Simai
Director, UNU/WIDER
December 1994

I INTRODUCTION

Internationalization is a key word describing one of the hot topics of today. It is widely used by business managers, public policy makers, rectors/deans and chancellors of universities, leaders of labour unions and representatives of cultural and social life.

In this report, the internationalization of Finnish firms as a response to domestic and global challenges is analysed. By internationalization, it is meant a step-by-step process of international business development whereby a firm becomes increasingly committed to and involved in international business operations through specific products in selected markets. This development is supposed to be a sequential and orderly process, as presented by the stage theory of internationalization, developed mainly by the Scandinavian researchers Luostarinen (1970, 1978a, 1978b, 1978c, 1979) and Luostarinen and Hellman (1994) in Finland; Johanson and Wiedersheim-Paul (1975) and Johanson and Vahlne (1977, 1990) in Sweden, tested by Juul and Walters (1987) in Norway and further elaborated through the Australian-Nordic combinations Welch and Wiedersheim-Paul (1980), Welch and Luostarinen (1988) and Luostarinen and Welch (1990).

This report is partly based on a speech by the author on the Internationalization of Finnish Firms, on May 3, 1994 at UNU/WIDER. The main data used in this report is based on data from Finland's International Business Operations (FIBO) Research Programme at the Helsinki School of Economics. Since the FIBO Research Programme's establishment by Reijo Luostarinen in 1974, it has concentrated on creating and developing data banks on internationalization and on analysing, theoretically and empirically, the dynamics of the internationalization of firms in a small and open economy (SMOPEC). The mission of the FIBO Research Programme has included both the study of the internationalization of Finnish firms abroad and the operations of foreign and multinational companies in Finland. In addition to internationalization at the micro (firm) level, internationalization at the meso (industry) level and at the macro (country) level has also been studied albeit on a minor scale.

Since 1992, the Center for International Business Research (CIBR), directed by Reijo Luostarinen at the Helsinki School of Economics, has been conducting major research efforts in international business at the doctorate and post-doctorate levels. A recent CIBR study on *Globalization of SMEs* (Luostarinen, Korhonen, Jokinen and Pelkonen 1994), which is a part of an extensive OECD project, is referred to in this report.

Further, a CIBR study on the birth, development, growth and internationalization of Tanzanian industrial firms, which is the first part of the large World Bank 'Regional

Programme of Enterprise Development in Africa' RPED project (Luostarinen, Blanc, Kauko and Al-Obaidi 1994) is partly utilized.

The seven different International Business (IB) study programmes offered by the Helsinki School of Economics create an excellent basis for ensuring qualified, high calibre and strongly IB-oriented researchers for the CIBR and FIBO Research Programmes.

II INTERNATIONALIZATION OF FINNISH FIRMS BASED ON A SMALL AND OPEN ECONOMY (SMOPEC)

In the 1960s and the 1970s the well-known slogan within Finnish industries was 'export or die'. In the 1980s the slogan became 'internationalize or die', and in the 1990s it has changed into the form 'globalize or die'.

These slogans have indicated two important aspects for the Finnish economy and Finnish firms: the crucial meaning of international business and the evident changes in the scope of international business from export through internationalization towards globalization.

2.1 Internationalization at country, industry and firm levels

Internationalization can be analysed at many levels (Luostarinen 1970). In this report it is performed at three levels:

1. Country level;
2. Industry level; and
3. Firm level.

Country level

Country level analysis indicates that up until the 1960s it was the manufacturing sector which was responsible for export and other international business activities (see Table 1). During the first half of the 1970s the construction industry started to internationalize its activities. This was largely due to the oil crisis, which caused a huge transfer of purchasing power to the oil producing countries and led to a rapidly growing demand for all kinds of construction and infrastructure projects in those countries. Finnish building companies wanted to take their fair share out of that new 'business cake'.

During the second half of the 1970s, Finnish service companies (banks, insurance companies, engineering firms, management consulting companies, advertising agencies, etc.) started international business operations. The major motive was obvious: they wanted to utilize new business opportunities made available by their domestic industrial customers who had started to internationalize earlier and who needed similar services abroad. In addition to this opportunity pull, there was in many cases also a threat push. If Finnish service firms had stayed at home, they would have lost both the new foreign demand and even the existing domestic demand to their international competitors who, through their global subsidiary networks, would have been able to offer integrated and coordinated services to Finnish customers. So it was a 'follow the

customer' strategy which acted as a trigger for Finnish service firms. Some shipping and forwarding firms had started their foreign operations earlier to serve their exporting customers, but the main part of the service sector did not start to internationalize until the late 1970s.

Finally in the 1980s and especially in the early 1990s, the last domestic sector of the Finnish economy, retail and wholesale business, entered the international market place. This was partly due to new business potential abroad and particularly to the emergence of the Eastern and Central European states in transition.

TABLE 1
INTERNATIONALIZATION ORDER OF DIFFERENT FIELDS OF BUSINESS
IN FINNISH ECONOMY

Order	Field of business to be internationalized
I	Manufacturing industry (1850-)
II	Construction industry (1970-)
III	Service industry (1975-) (except shipping, forwarding)
IV	Retail business and wholesale business (1980-)

Industry level

Up until the 1960s, forest and metal industries had been responsible for export operations (see Table 2). This stage is called the 'traditional export stage'. Traditional industries entered, penetrated and escalated foreign markets by using traditional exporting modes.

In the 1960s, a significant change took place. Companies other than forest and metal companies started to foster international business. Industries such as textile, clothing, leather shoe, electrical, plastic, etc., entered foreign markets on a greater scale. The Finnish media used the term 'new export' for this phenomenon. As the term indicates, traditional export operations were still used as an operation mode for internationalization but by 'new' industries which had been completely domestically oriented earlier. Nationally this era was very important for Finland. After the Second World War there was a hectic need to find a significant place on the world map again. In addition to the Helsinki Olympic Games, the last shipment of war reparations to the Soviet Union and a Finnish beauty being awarded the Miss Universe title, the 'new export' helped the nation to find its trust, hope and national identity again.

In the 1970s the industrial firms which had started their internationalization through traditional exports entered a new stage of internationalization – a foreign operations stage. In addition to indirect and direct exporting they started to use other, more efficient modes of doing business abroad, such as licensing, subcontracting,

contract manufacturing, partial projecting, turn-key projects and different types of subsidiary operations.

The international stage was reached in the 1980s. Due to the increasing use of different types of foreign operations, companies grew heavily and the share of international business operations in total sales exceeded 50%. This development created entirely new challenges for the firms. Home market-based information, planning, decision-making, organization and control/evaluation system structures had to be expanded to meet the requirements of the international markets from which the major part of the turnover was coming.

It is logical to argue that the 1990s will be the stage of globalization. Most of the existing evidence indicates that the European market is not enough for all the internationalizing firms. Some firms need larger markets to cover large R&D investments, some have developed global product innovations and for some, competition is global – not only European – by nature. The challenge is enormous: small firms from a small country and with limited resources will have to meet the largest possible challenge – global markets.

TABLE 2
INTERNATIONALIZATION PROCESS OF FINNISH INDUSTRIES

Order	Internationalization stages of industries	
I	1860–1960	Traditional export stage - forest and metal industry
II	1960–1970	New export stage -other industries
III	1970–1980	Foreign operation stage
IV	1980–1990	International stage
V	1990–	Globalization stage

Company level

When analysed at a single company level, internationalization seems to proceed in a particular order. The first operation mode used is one of the exporting modes. This is followed by the sales subsidiary stage. Through licensing, subcontracting or contracts, manufacturing firms finally move to the production subsidiary stage (see Table 3).

The rationale behind this stepwise development seems to be that through the exporting stage a firm is able to test market acceptance for its product with minimal risks. If the demand potential is promising, the second step is to increase the sales power on selected target markets by establishing a sales unit. Through licensing or some other mode of non-investment production operations the manufacturing conditions can be

tested before taking the fourth step, i.e. establishing the firm's own production unit in a foreign country.

TABLE 3
INTERNATIONAL STAGES AT THE COMPANY LEVEL

Order	Internationalization stages of manufacturing
I	Export operation stage
II	Foreign sales subsidiary stage
III	Licensing, contract manufacturing and/or subcontracting stage
IV	Foreign production subsidiary stage

2.2 Factors explaining internationalization

An interesting question is: Which are the factors explaining internationalization and the advance through the described stages for firms in Finland? According to the power field analysis there are global, international, domestic and company-specific forces (see Figure 1). Global forces are those common to firms in many different countries whereas domestic forces are those country-specific factors which are less common for firms in other countries. International forces are between these two.

The most common global forces behind the internationalization of Finnish companies in the 1970s – 1990s are listed as follows:

1. World trade has been growing faster than the world GNP;
2. Total global Foreign Direct Investment (FDI) has been growing faster than trade over the past 20 years;
3. The dependence between rivals in different parts of the world is increasing;
4. The globalization of industries and businesses is increasing;
5. The nature of global competition is changing due to increased international networking, cooperation and alliances;
6. Capital markets have been deregulated;
7. Area integration is increasing, that is, liberalization of capital, human, product and service movements;
8. Eastern European nations are moving towards market economy systems;
9. The development of instantaneous international communication;
10. The end of the cold war;

11. A greater emphasis on economic affairs than on political and/or military affairs;
12. A surge in cross-border travelling;
13. International transportation is increasing in speed and scope;
14. The internationalization of cultural relations, labour unions, etc.
15. Increased international awareness of people due to education, research, travelling, media and foreign contacts.

FIGURE 1

POWERFIELD FOR THE INTERNATIONALIZATION OF FINNISH FIRMS

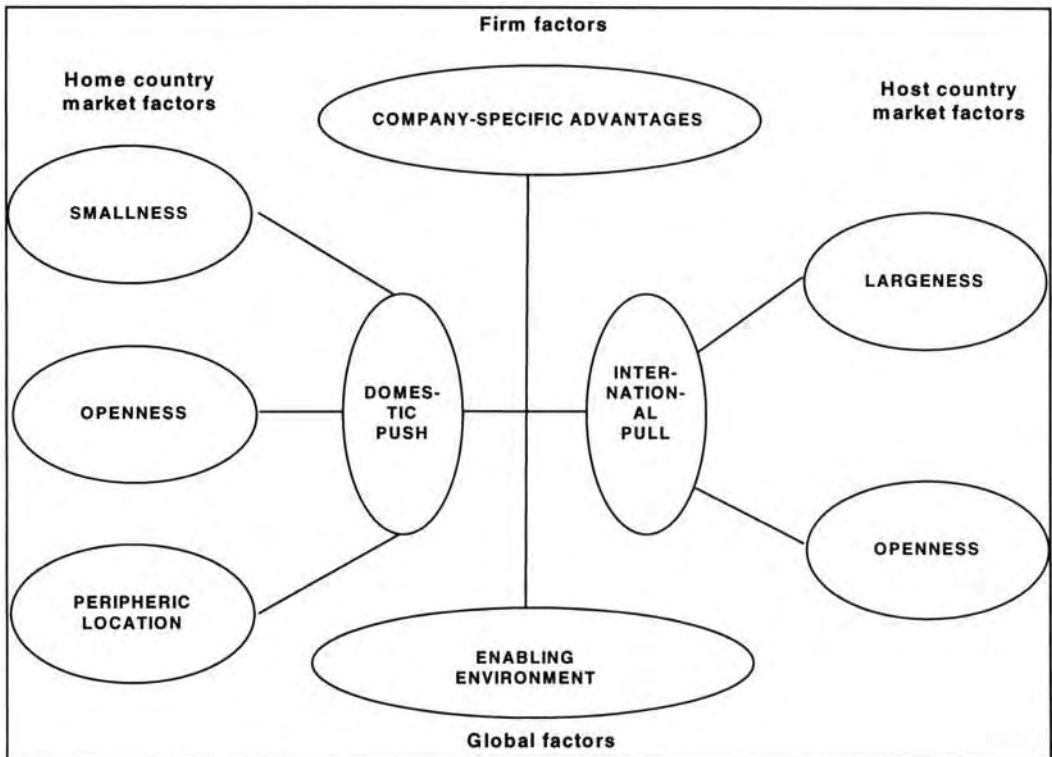

Compare Luostarinen 1982:136.

According to a Finnish study (Luostarinen 1979), there are three important domestic macro factors acting as push forces for the internationalization of Finnish firms. These are the small size, openness and peripheric location of the domestic market. Out of 1,006 industrial firms engaged in international business activities, 70% indicated that the smallness of the domestic market had an important or very important role in their internationalization. Altogether 78% of the companies projected that 50% or more of future growth has to be obtained from the international market (Luostarinen 1979). These empirical results clearly indicate that domestic growth opportunities are of secondary importance and internationalization has become the major growth strategy for these firms (see Figure A1 in the Appendix and Luostarinen 1980). Due to the continuously increasing openness of the domestic market (agreements: GATT 1950,

EFTA 1961, EC 1973, COMECON 1974-75, EEA 1994 and EU 1995), it has become relatively speaking, still smaller.

Peripheral location is increasing the pressure to internationalize. Finland is located far away from its major European and other markets and is isolated by the sea from these markets. In practice this means that Finnish firms are located far away from the cross-roads and major avenues of international trade in general and of the related international business impulses in particular. In order to get the same amount of international business impulses that passive companies located in Central Europe receive, Finnish firms have to be very active. Similarly in order to be able to follow the development of trade, demand, competition and technology in the major European markets, Finnish firms have to step out of domestic markets into the international arena. These three home country factors form a very high push or pressure force for internationalization.

At the same time, host country based macro factors form an international pull force. The two distinct pull forces for Finnish firms are the large size and reciprocal openness of foreign target markets. As Finland's domestic market is one of the smallest in developed countries, when a Finnish firm enters the market of a developed economy, the foreign market is almost always larger than the Finnish market. This large size of international markets acts as a pull force for internationalization. In principle, other things being equal, it should be easier for a Finnish firm to reach a certain volume of sales in large foreign markets than in its small domestic market. This is due to the fact that if a Finnish firm has a 40% market share at home, its market share in a foreign market would be smaller with the same volume of sales, for example in the German market it would only be about 3%.

Because the trade liberalization agreements signed by Finland are either bilateral or multilateral, the Finnish market – measured by the height of the tariff walls – is the most open in the world. Reciprocally the world market is more open to Finnish firms than for firms from competing countries. Whether the openness is offering more advantages than disadvantages depends largely on Finnish firms. If they decide to fully utilize the possibilities offered by the continuously opening world market, then the advantages outweigh the disadvantages. If they do not, then the result will obviously be the opposite. Openness has offered Finnish firms opportunities to participate in the international division of labour, to specialize in selling such products globally where the firms have competitive advantages and to buy products from abroad which either cannot be produced or competitively manufactured in Finland.

The fourth group of forces acting for internationalization is the company-specific advantages gained through internationalization. These advantages act as micro-based pull forces. The following are the major advantages gained by Finnish firms.

Advantages of economies of scale

When a firm acts in domestic markets which are much smaller than those of its foreign competitors, it may have difficulties in competing successfully. This is due to

the fact that for some products the unit costs are closely related with the amount manufactured and sold. In some R&D-intensive businesses, research and development investments are so large that there is no possibility of financing them if the firms are acting only in the small Finnish market. So, through internationalization Finnish firms are better able to enjoy the advantages of economies of scale.

Advantages of specialization

The competitive strategies often recommended to Finnish firms are specialization and focusing. However, due to the small domestic market, proper specialization in some product sectors and focusing on satisfying some selected customer groups is not possible. Within a small domestic market, the demand simply is not enough for the commercialization of a narrow business idea (niche business). However, when international or sometimes global markets are taken as a starting point, specialization strategy has completely different possibilities. So, specialization and internationalization go hand in hand, and the higher the degree of specialization, the higher should be the degree of internationalization.

Advantage of global alternatives

Domestically operating companies usually know, or are mainly able to utilize only alternatives available within domestic markets. The advantage of operating internationally is that a company is able to use foreign, even global alternatives. Whatever the functional decision-making area (purchasing, manufacturing, selling, financing, personnel, taxation, R&D, etc.) the firm can seek an optimal solution on a global basis. This fact partly explains the growth and power of large multinational enterprises (MNEs). However, smaller companies are also able to enjoy the enormous advantages of being able to operate on a global basis and, step by step, to become mini-MNEs.

Integration advantages

Integration advantages are mainly available for those companies which have advanced to more mature stages of internationalization. These companies are able to start, for example, planning and implementing the logistics for international production and material management. Through first enjoying the advantages of selecting the best alternatives for production in different areas, the company can start integrating its production processes and material/product flows, thus reaping the advantages of inbound production and outbound logistics on a regional and global scale. It may be, for example, that the production system is fully restructured globally. Through historical development the company may have a group of production units manufacturing finished products, each of them having their own subcontractor network. After the global integration of the logistics, the company has some central assembly units producing saleable products with components supplied by satellite factories and specialized subcontractors. This is how every unit specializes in utilizing its competitive edges, core competencies and location advantages for the benefit of the company as a whole instead of optimizing its own results.

When these company-specific advantages are added to the picture, the basic power field for internationalization is available. Global forces facilitate the internationalization process by offering an environment which is more and more positive for the international growth of the company. Domestic push forces are pressuring the company to go abroad, and simultaneously international pull forces are drawing the company to internationalization. So, these three macro powers act together in the same direction thus forming a strong basis and source of trigger signals to the company to get involved in the internationalization process (outward). However, even strong push and pull forces are not necessarily enough unless the company is able to recognize and identify the advantages it would gain through internationalization. That is why the company-specific advantages form the final motivational basis which makes the company willing to start the process.

2.3 Internationalization as a holistic stage process

The previous analyses of internationalization at the country, industry and company level indicate that internationalization seems to be, as suggested before, a step-by-step process where different stages follow each other in a logical order. In the following, the internationalization process at the company level is reviewed in a more detailed manner by using large data banks on the internationalization of Finnish manufacturing firms collected by the FIBO Research Programme at the Helsinki School of Economics in 1976, 1983 and 1990. These three studies include 1,006, 1,197 and 593 industrial firms respectively. By collecting almost population wide longitudinal data, the dynamics of internationalization can be studied on a more reliable basis than by using case analyses only. Major contributions of these studies are the following:

1. *Within the internationalization development of firms a wide variety of operation modes are used.*

However, in research works and studies on internationalization, only a small number of operation modes are included in the analyses of the internationalization strategies and processes of the firms. This naturally leads to a very limited, picture of the internationalization behaviour of firms.

The operation modes usually included are:

1. Traditional export operations;
2. Licensing operations (sometimes);
3. Direct investments in sales and production, i.e. sales and manufacturing subsidiaries.

For example, this means that heavy system operations like partial, turnkey and turnkey-plus operations, which are sometimes very important for construction and industrial companies, are omitted. Similarly, know-how operations which sometimes may be the only outward operation of a firm, are not included in the analysis.

Major reasons for these omissions are the lack of data, difficulty in dealing with many different operation types and willingness to concentrate on the major, opposite types of operations (exporting, subsidiaries) and on the internalization aspects of the internationalization (FDIs).

On the basis of the data collected, it is evident that as to the different modes of outward international business, at least 15 different types can be identified (Luostarinen 1978a, 1979). In order to be able to deal with such a large number of operation types, modes were divided into four major clusters or categories by using the two most important dimensions as tools, functional and foreign direct investment. The first dimension pays attention to the function of the firm (production or marketing) which is to be internationalized and the latter to whether the operation in question includes foreign direct investment flows or not. The classification and operation modes included were as follows (Luostarinen 1970, 1979):

- A. Non-investment marketing operations (NIMOs)
 - 1. indirect exporting
 - 2. direct exporting
 - 3. own exporting

- B. Direct investment marketing operations (DIMOs)
 - 4. sales promotion subsidiaries
 - 5. warehousing subsidiaries
 - 6. service subsidiaries
 - 7. sales subsidiaries

- C. Non-investment production operations (NIPOs)
 - 8. licensing
 - 9. franchising
 - 10. contract manufacturing
 - 11. co-production
 - 12. partial projects
 - 13. turnkey projects

- D. Direct investment production operations (DIPOs)
 - 14. assembly subsidiary
 - 15. manufacturing subsidiary.

As can be seen, in addition to the internalization modes (DIMOs and DIPOs), externalization operation modes (NIMOs and NIPOs) are included.

As to the direct investment operation modes, DIMOs and DIPOs, even the above picture is too narrow. Within the FIBO programme, a large data base project has been started on foreign subsidiaries of Finnish firms by reorganizing the old manual data banks created by Luostarinen since 1968 and by beginning a project with Finnish commercial counsellors and directly with Finnish firms through financing from the

Ministry of Trade and Industry. Altogether 6,900 subsidiaries have already been included in the computerized register. One of the most interesting results has been the number of different types of subsidiaries. Usually only sales, marketing, assembly and manufacturing subsidiaries, i.e. marketing and production subsidiaries have been paid attention to in other studies. Our studies (Luostarinen 1978a, Hentola 1994) indicate that companies, in practice, use altogether 22 different types of subsidiaries abroad. It is no longer only marketing and production functions which are internationalized through subsidiary operations, but also all other functions like purchasing, financing, holding, R&D, logistics and administration. However, international business theories do not include these, thus being partial by nature.

2. *Internationalization of firms is not a one-dimensional concept (to be analysed only through the operation dimension) but a multidimensional concept. That is why the internationalization behaviour of firms should be analysed using a multi-variable or multi-dimensional approach.*

In FIBO studies, a product, operation and market (POM) concept (see Table 4) was developed for measurement and analytic descriptive purposes (Luostarinen 1979).

TABLE 4
MAJOR COMPONENTS OF INTERNATIONALIZATION STRATEGY

P roduct strategy	What	(product types)
O peration strategy	How	(operation modes)
M arket strategy	Where	(markets entered)

Naturally this does not mean that there are no other dimensions for internationalization. Very often the internationalization of organizational structure, finance and personnel are used as measures for the degree of internationalization of a firm or as additional dimensions when comparing the internationalization profiles of different firms (see Figure 2).

Other possible measures used are:

1. Internationalization of ownership;
2. Internationalization of information, planning and decision making; and
3. Internationalization of the percentage of sales and production volume, and of profit figures and of different assets (see Luostarinen 1978b).

The key question of the studies was whether any orderly and consistent pattern could be found in the development of the firm's POM posture during the increasing involvement in international business. The results are presented in Tables 5, 6 and 7.

For all of these three components of the internationalization strategy, a fairly consistent and orderly mainstream pattern was identified. The product strategy (intended or emerged) for internationalization developed through the following steps: goods, services, systems and know-how. The operation strategy advanced in the order of NIMOs (non-investment marketing operations), DIMOs (direct-investment marketing operations), NIPOs (non-investment production operations) and DIPOs (direct-investment production operations).

FIGURE 2
HYPOTHETICAL COMPANY PROFILES BASED ON DIFFERENT DIMENSIONS
OF INTERNATIONALIZATION

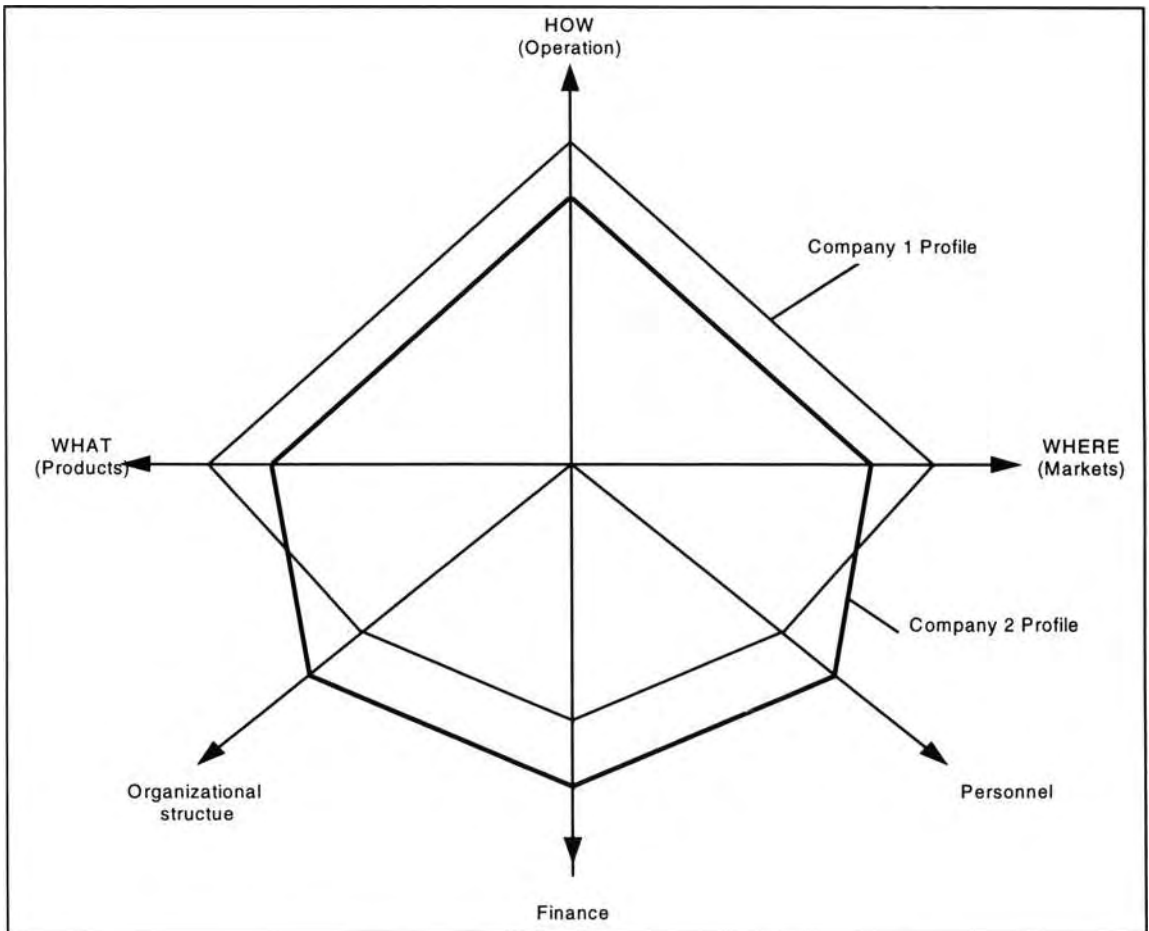

Source: Luostarinen and Welch 1990:257.

As for the market strategy, the companies first entered the markets that were geographically, culturally and economically close, i.e., markets at short business distances, and then gradually advanced to the markets at longer business distances. On this basis, companies can also be classified as Nordic, Euro- and global enterprises.

Naturally, the more steps which were included, the less consistent these patterns were. It should be mentioned that these patterns were identified at the company level (internationalization pattern of the firm) and not at the target country level (penetration

pattern of the target market). Even if the same stages of operations were identified for a single target country as a penetration pattern (NIMOs, DIMOs, NIPOs, DIPOs), this was more often the case at the beginning of the internationalization process than at the more mature stages (see Figure 3).

TABLE 5
THE CHRONOLOGICAL ORDER OF INTRODUCTION OF DIFFERENT INTERNATIONAL BUSINESS SALES OBJECTS IN 998 FINNISH COMPANIES

Order of introduction	I	II	III	IV
Product category				
Goods	(99)	4	1	4
Services	0	(47)	19	4
Systems	0	19	(48)	4
Know-how	1	30	32	(61)
Total percentage	100	100	100	100
N	998	217	84	26

TABLE 6
THE ORDER OF UTILIZATION OF DIFFERENT OPERATION MODES IN 997 FINNISH COMPANIES IN 1976

Order of utilization	I	II	III	IV
Operation mode				
NIMOS	(98)	5	1	-
DIMOS	1	(64)	24	20
NIPOS	1	21	(44)	20
DIPOS	0	10	31	(60)
Total percentage	100	100	100	100
N	997	309	106	20

TABLE 7
THE ABSOLUTE AND RELATIVE FREQUENCIES OF THE FIRST FOREIGN ENTRY OF 924 FINNISH COMPANIES BY MARKET CLUSTERS BASED ON BUSINESS DISTANCE

Market cluster by business distance	Company frequencies	
	Absolute	%
Very close	847	91.7
Close	43	4.7
Medium	16	1.7
Distant	16	1.7
Very distant	2	0.2
Total	924	100.0

Source: Luostarinen 1979;103, 123 and 151.

FIGURE 3

INTERNATIONALIZATION PATTERN OF THE FIRM AS A SUM OF TARGET COUNTRY PATTERNS

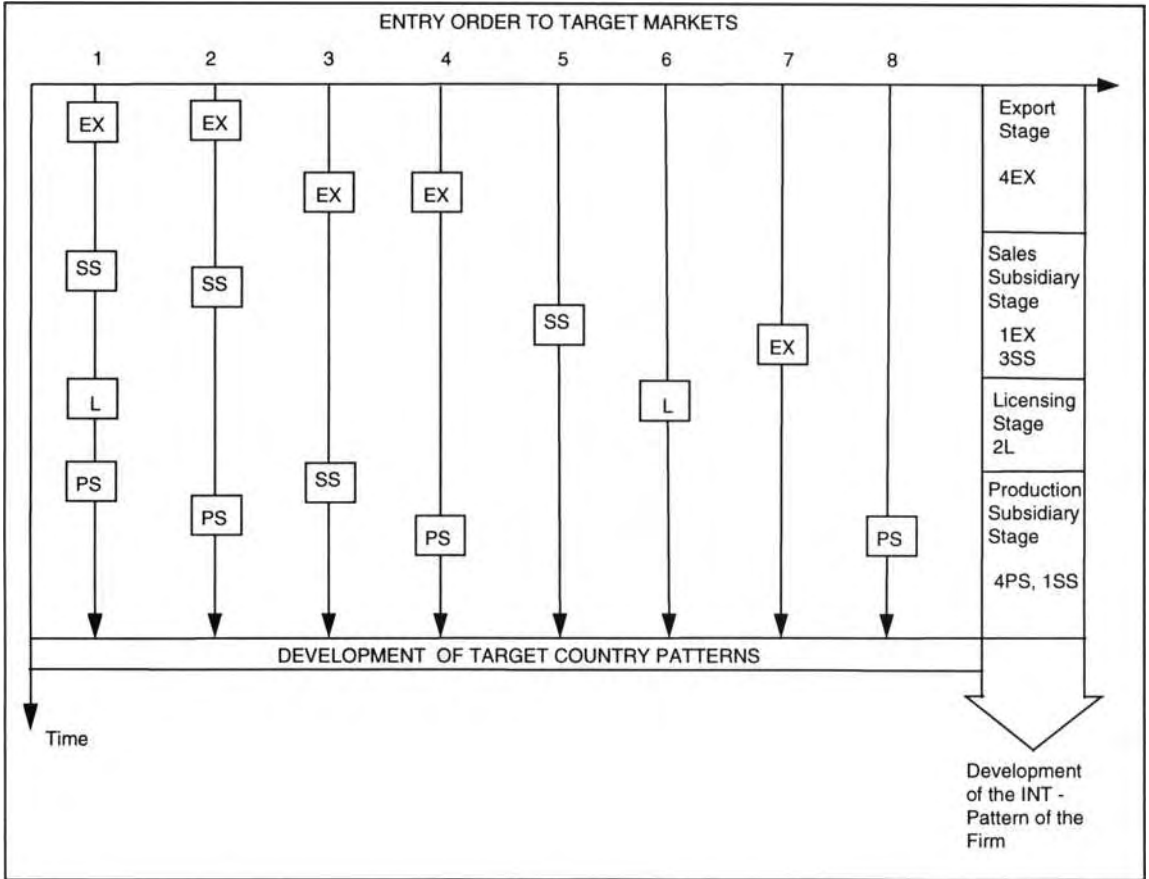

Source: Luostarinen and Welch 1990:264.

When the product, operations and market patterns are combined, we get the total POM pattern of the firm on the basis of which the internationalization of the company can be divided into starting, development, growth and mature stages of internationalization (see Figure 4).

Empirical evidence shows that 97% of the Finnish industrial firms started their internationalization by using NIMOs modes for their physical goods in markets which in 90% of the cases belonged to the cluster of hot countries, i.e., to the target countries at a short business distance (see Figure 5). At the development stage two major alternatives were identified: 42% of the companies started to use direct sales/marketing investments in hot countries (88%) and 23% added services through NIMOs in hot countries (76%). At the growth and mature stages the pattern was much less consistent which is fully in accordance with the increased learning and lateral rigidity theory (Luostarinen 1979).

FIGURE 4

COMBINING THE DYNAMIC PRODUCT, OPERATION AND MARKET PATTERNS INTO A HOLISTIC POM-PATTERN WITH DIFFERENT STAGES

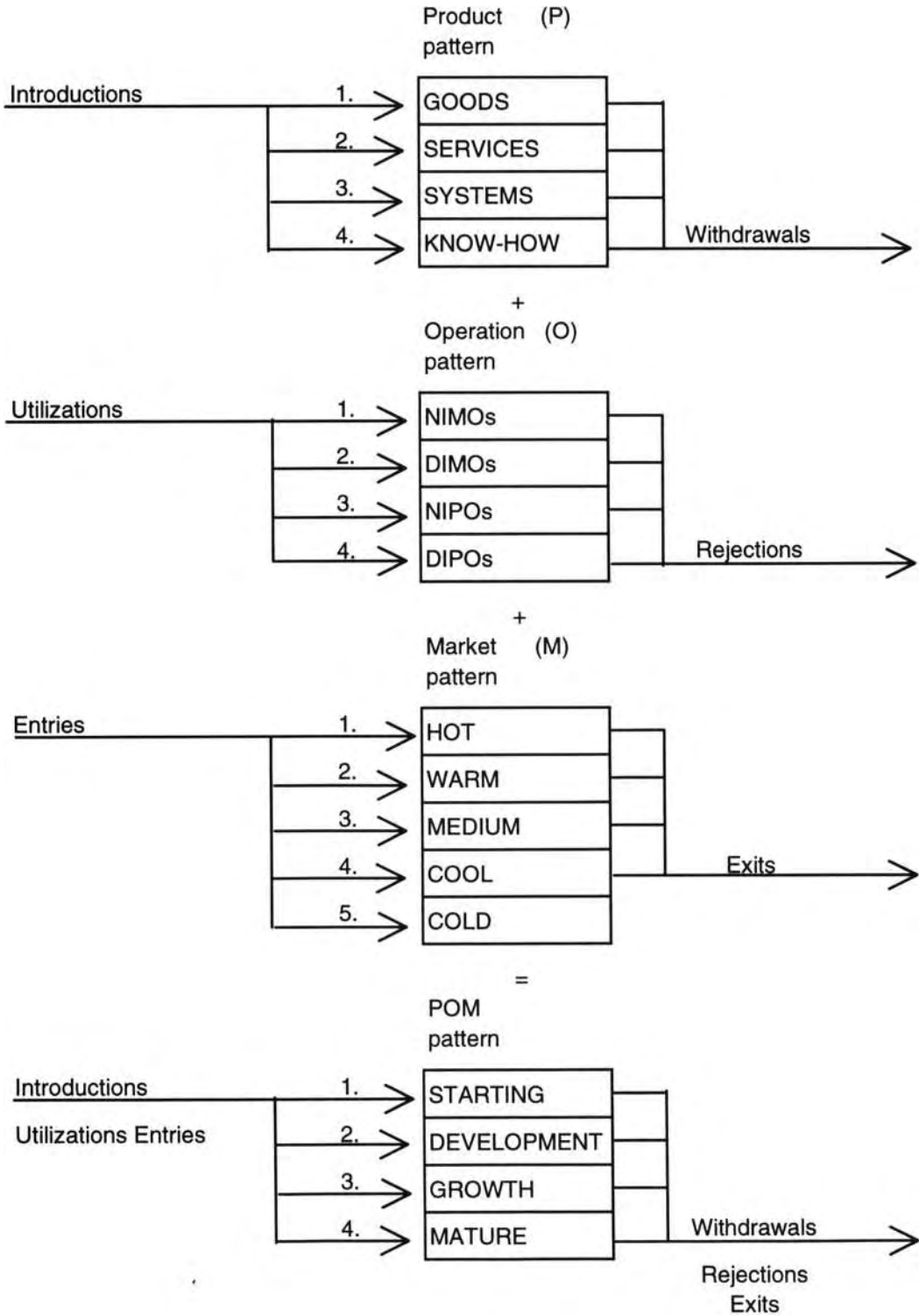

Source: Luostarinen 1979:182.

FIGURE 5

MAINSTREAM MODELS OF THE INTERNATIONALIZATION PROCESS OF FIRMS

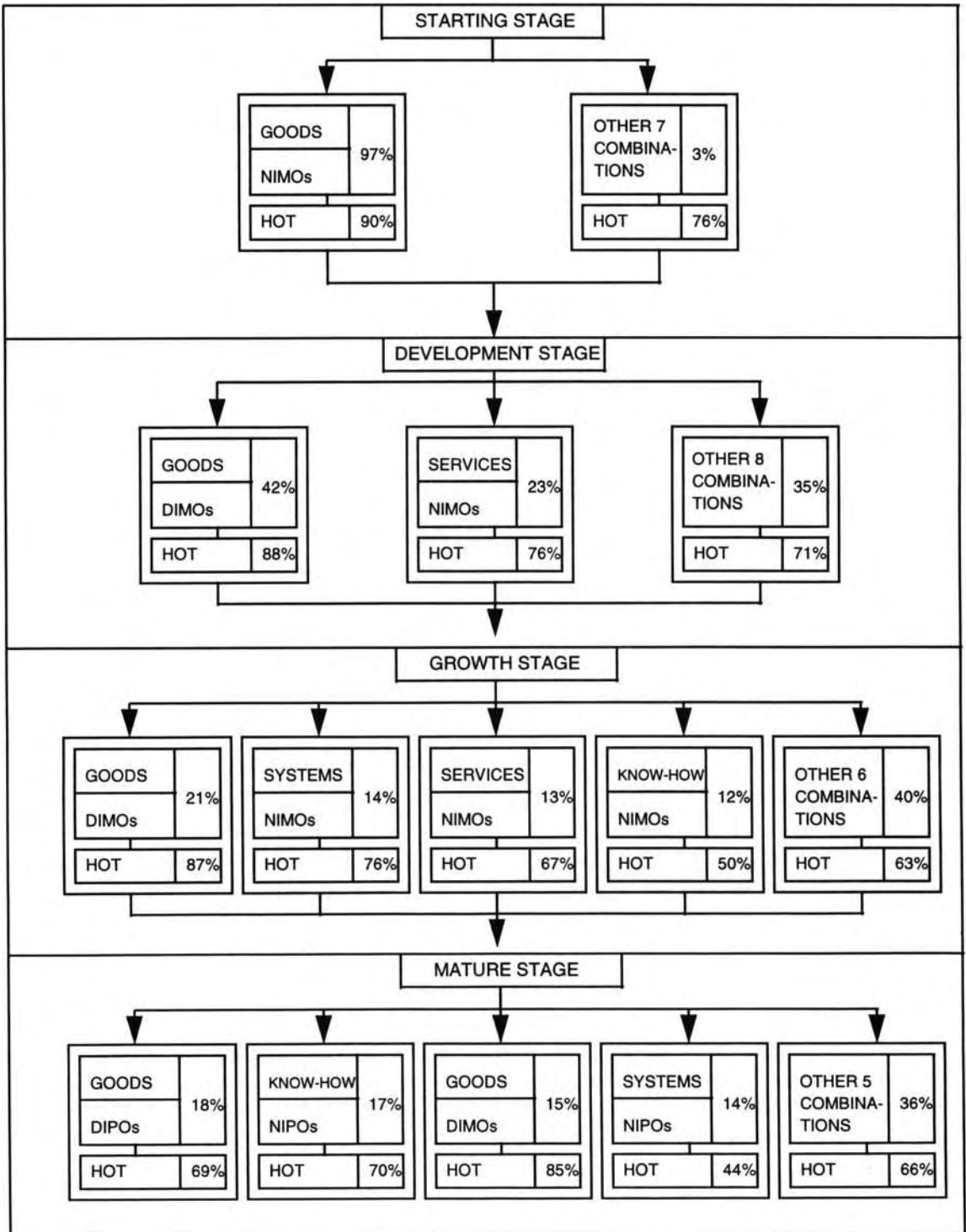

Source: Luostarinen 1979:186.

3. *Internationalization is not a one-way, but a two-way phenomenon. This is why not only outward internationalization through outward operations but also inward internationalization and cooperative forms of internationalization should be studied.*

When the operation dimension of internationalization was studied on this broader basis, the results again referred to a kind of a mainstream model or pattern of behaviour. Most of the companies started their internationalization first with inward steps, proceeded then to outward stages and finally towards cooperative phases. The larger the firm, the more valid was this pattern of internationalization (see Table A1 in Appendix).

The rationale explaining this stepwise behaviour seems to be that when a firm is established, it imports technology and machinery or production processes – sometimes even the whole factory – from abroad in order to get the best possible start for manufacturing the product in question (see Figure 6). When the production process is started, the company may import some of the raw materials and/or components from abroad. After successfully testing its competitive capabilities in domestic markets and reaching a dominating or 'saturated' market share, the company usually starts its outward internationalization process. Sometimes this is done on the basis of further developed production systems and/or product innovations. However, the inward internationalization may still proceed hand in hand with the outward operations. For example, the company's product range may be diversified by infusing a new product innovation through inward licensing. Finally companies seem to realize that globalization demands cooperation with foreign companies, i.e., different types of strategic alliances and networks.

4. *There may be close interaction between inward, outward and cooperative internationalization.*

It is often forgotten that the inward operations are sometimes heavily connected with the outward operations. There is a possibility that an individual firm can select its foreign supplier on the basis of its ability to contribute also to the outward internationalization of the firm (Welch and Luostarinen 1993:4-57).

There are a number of possibilities of how the inward and outward sides of internationalization may develop and affect each other. Countertrade is also a good example of interconnections. Complex webs of operations are the most developed forms of inward-outward connections. Many multinationals have been capable of developing these with and between their subsidiaries. Strategic alliances and other cooperation modes are often connecting inward and outward international movements in the internationalization process. A connection generated by an inward operation may lead to a formal contractual link and a direct relationship. For example, when inward foreign licensing is followed by outward technology sales, it may eventually lead to a formalized cross licensing contract. Although the interconnections may not be very clear in the early stages of an enterprise's internationalization, there are various possibilities in

which inward operations might contribute to outward going operations (Luostarinen and Welch 1990).

FIGURE 6

STAGES OF THE HOLISTIC INTERNATIONALIZATION PROCESS OF A FIRM BASED ON THE OPERATION MODE DIMENSION

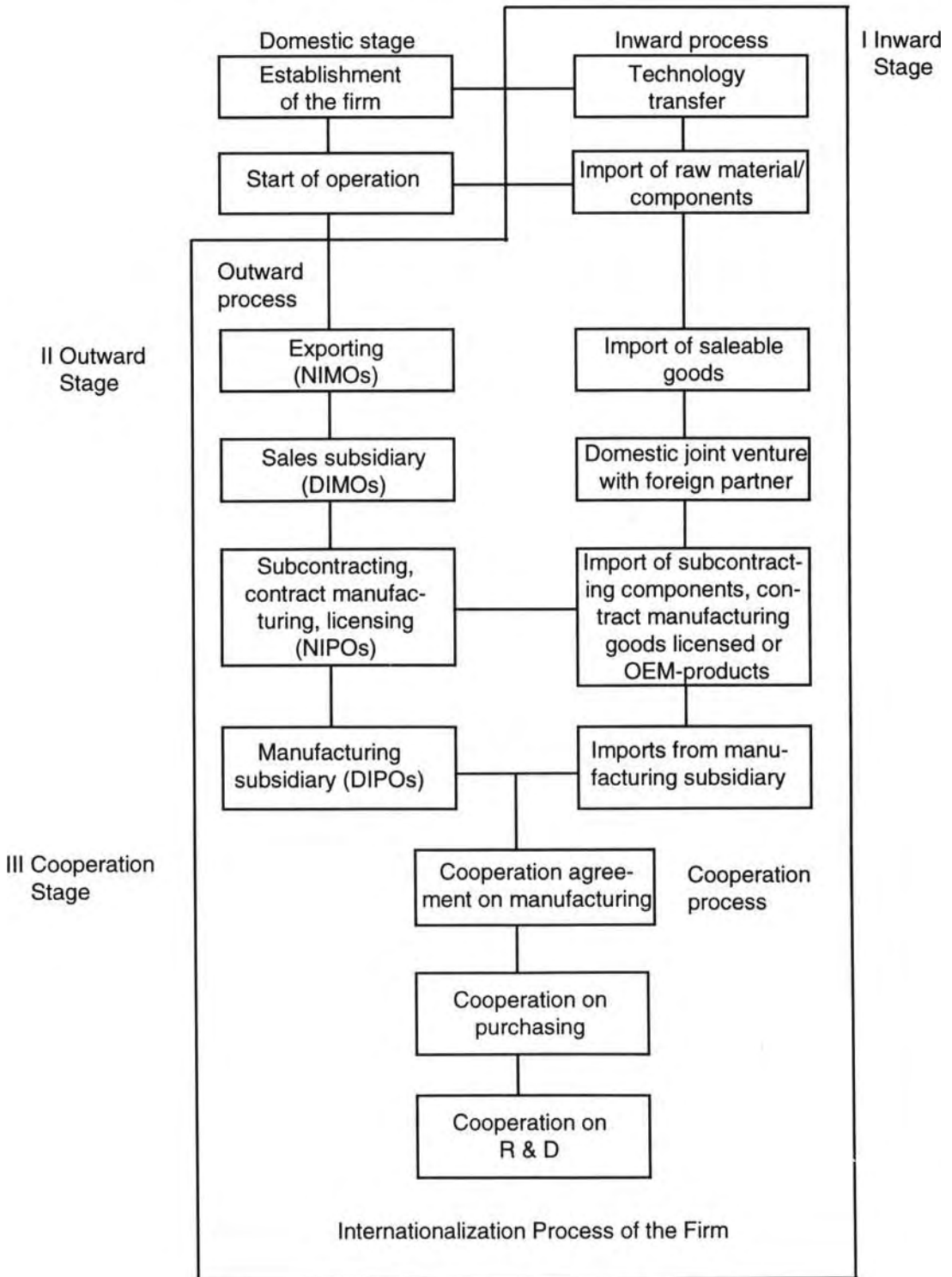

Source: Luostarinen 1989; Luostarinen and Hellman 1994:8.

There are two ways in which inward-outward relationships in internationalization can be classified:

1. Direct relationships in which overt dependence is typical; and
2. Indirect relationships in which there are usually not much dependence of one movement on the other (see Figure 7).

FIGURE 7
INWARD-OUTWARD RELATIONSHIPS DIVIDED INTO DIRECT
AND INDIRECT CATEGORIES

Direct relationship	Indirect relationship
<p>e.g. countertrade; cooperation deals; cross licensing; multinational corporations; in-house transfer network; international sub-contracting.</p> <p style="text-align: center;"> </p> <p>Often contractual in nature, or subject to centralized decision-making by MNE.</p>	<p>e.g. experience as importer of technology to outward foreign licensing; foreign supplier leads to foreign contact and orders.</p> <p style="text-align: center;"> </p> <p>Typically there is a time separation; learning process and type of international contacts are important.</p>

Source: Welch & Luostarinen 1993:46.

5. *Internationalization should not and cannot always proceed along the lines of the mainstream pattern.*

In order to survive today, Finnish firms in the most dynamic sectors need to react quickly to the changing external environment. They need to be more elastic in their strategic decision-making than before. This causes leapfrogging in the traditional pattern of internationalization. Therefore, for some firms, e.g., newly established relatively small companies which produce unique and special products, the pattern of internationalization seems to be:

- A. Domestic stage
 - i. a very short domestic stage, or
 - ii. simultaneous domestic and foreign stage, or
 - iii. no domestic stage.
- B. Any of the stages in the traditional pattern of internationalization (see Figure 6).

6. *Internationalization is not always a forward process, but it may also be a backward process followed perhaps again by advancing steps, i.e., internationalization may be followed by de-internationalization and re-internationalization.*

The most common reason for a company to make a de-internationalization move is the failure of the operations in question. However, de-internationalization may also be due to so-called involuntary internationalization. Involuntary internationalization means, for example, that the company is forced to start local manufacturing or to withdraw from the market because of government restrictions (Luostarinen 1970:136-7). There may be great pressure for a company to move forward in the internationalization process but if these forces which drive the company to globalize are removed, there could be backward movement. This was the case, e.g., with the Vaisala Corporation. At the beginning of its internationalization it felt, due to competitive pressure, that it needed to have licensing operations in Sweden and Norway and production subsidiary operations in Argentina and South Africa. When the threats were removed, the company cancelled these operations and continued with traditional exporting (Janatuinen 1984).

According to Luostarinen (1979:118 and 201), re-internationalization may occur after de-internationalization. This is due to the learning process from the first internationalization experience. A company which has gained experience may try, on that basis, to avoid the mistakes of earlier operations.

2.4 Criticism on the stage pattern of internationalization

The results of the studies on the stepwise orderly development of outward internationalization have been criticized. The major arguments of the critics have been:

1. Companies do not internationalize in an orderly way (Turnbull 1985, Hedlund and Kverneland 1983);
2. Companies may also stop at a particular stage without proceeding further, jump over the stages or even reverse the process;
3. Empirical evidence on the stage pattern is based mainly on four Swedish cases (Turnbull 1985);
4. Empirical evidence is only based on small Scandinavian countries (Turnbull 1985).

As we have seen, this criticism is partially based on concepts of internationalization which are too narrow and on analyses of the existing literature and studies which are too limited.

To begin with, there are two major stage patterns of internationalization which should be clearly separated from each other: a target country pattern of internationalization and a company pattern of internationalization. The company pattern

is a sum of the target country patterns of the firm (Luostarinen 1970, Luostarinen and Welch 1990). Based on empirical evidence (Luostarinen 1979, Luostarinen and Hellman 1994) it is clear that a mainstream stage pattern at the company level does exist, and that the pattern is more valid at the company level than at the target country level.

Secondly, irregularities and exceptions from the mainstream pattern of internationalization have been clearly expressed both at the target country level (Luostarinen 1970, Johanson and Wiedersheim-Paul 1975, Johanson and Vahlne 1977) and at the company level (Luostarinen 1979, 1991 and 1994). Luostarinen, for example, states that this traditional stage pattern is not meant to be a normative pattern 'Firstly, it is too slow. Secondly, it is too rigid. And thirdly, it may start from the wrong end' (Luostarinen 1991:269) and that 'Negative experiences again may cause a company to withdraw from foreign markets and thus to de-internationalize its activities, possibly followed later by re-internationalization measures' (Luostarinen 1979:118 and 201, see also Häkkinen 1994).

Thirdly, there is a great deal of empirical evidence on the validity of the so-called mainstream pattern of internationalization at the company level. For example, in Finland there are 16 empirical studies based on the 1976, 1983 and 1990 data bases of 1,006, 1,197 and 593 industrial firms respectively. These studies all support the idea that companies are behaving in a fairly consistent way during their internationalization process. As a result, an orderly mainstream stage pattern of internationalization exists (Luostarinen 1979). This was also the case in small, medium-sized and large companies which were analysed separately (Valtonen 1992, Avikainen and Harra 1992, Huttunen and Posti 1992 respectively), in family and non-family enterprises (Hellman 1993, Luostarinen 1994, Luostarinen and Hellman 1994) and in firms active in 12 different industries.

Further, it is true that most of the studies stem from the members of the Scandinavian or Nordic school of the stage pattern. However, there is growing evidence to support the validity of the stage pattern from larger countries. Some of this research has taken place in North America concentrating on various steps involved in the foreign investment decision process (Aharoni 1966, Wilkins 1970, 1974) or on the steps related with early exporting operations (Bilkey and Tesar 1977, Cavusgil 1984, Yaprak 1985, Denis and Depelteau 1985; see also Welch and Wiedersheim-Paul 1980, Joynt 1981, Piercy 1981) or on both exporting and FDI's (Calof 1991).

2.5 Explanatory theories for stage development

The development of stages, analysed and described earlier, should not be called a 'theory'. Actually Nordic scholars have used the word 'pattern' or 'model'. Only after some researchers referring to the Nordic studies started to use the concept 'Stage theory' have Scandinavians partly started to follow this practice. Nordic scholars have preferred to use the concept 'theory' when they have been trying to explain consistent stage behaviour. In the explanatory parts of their works they have used the behavioural theory as a basis, but some building blocks have also been borrowed from the theory of the

growth of firms, decision-making theory and system theory (Johanson and Wiedersheim-Paul 1975, Johanson and Vahlne 1977, Luostarinen 1977 and 1979).

After this basic discussion, the next logical questions are: Why are most of the companies following the order indicated by the mainstream pattern? How can this kind of behaviour be explained? Having been able to learn through practice as a consultant, a member of strategic planning bodies, a member of the boards and as an entrepreneur, I have noticed that as decision-makers, business people behave in a peculiar way. They are very willing to repeat what they have implemented successfully in the past, but are very hesitant, even unwilling, to enter into something which is beyond their earlier experience and present knowledge. In other words, as strategic decision-makers they are elastic forwardly, doing the same as they have done earlier, but rigid laterally in the area of taking new steps to go in new directions and face challenges and changes which are unknown and from which they feel uncertainty and risk. This sounds very familiar to those who have read the research work, e.g., by Cyert and March (1963) on the behaviour of firms in general and by Aharoni (1966) on international investment behaviour in particular.

Based on these seminal works in the area of behavioural science of firms, the author constructed a laterally rigid behavioural decision-making model, which is presented in Figure 8 (for a more detailed model, see Figure A2 in Appendix). Through this model the components of the product, operation and market strategy could be organized into a so-called order of lateral rigidity, the first step component of each strategy being the best known, the least risky alternative and the last one the least known large risk alternative. As noticed, the empirical evidence was that most of the firms proceeded along these lines. It could also be observed that the degree of lateral rigidity was reduced through *organizational learning* and through the increase in the knowledge 'allowing' companies to advance gradually into new strategic options. Due to the organizational learning process, the target country patterns of the firm get more and more diversified without continuing to follow the traditional order of the stages.

The size of a firm seems to have an impact on the degree of lateral rigidity and through this on the internationalization of the firm – the smaller the firm, the smaller the financial resources, the less the personal resources and the lower the stock of knowledge and the higher the lateral rigidity. Our empirical studies clearly indicate that smaller firms have internationalized less, more slowly and passively than larger firms (Avikainen and Harra 1994, Huttunen and Posti 1994, Valtonen 1992).

Family ownership also seems to have a connection with the degree of lateral rigidity. Small family firms have internationalized less, more slowly and passively, by using mostly traditional operation modes, with a longer domestic period and with poorer results than small firms which are not family-owned. This is obviously due to the higher lateral rigidity towards internationalization in small family firms. Often in family firms the basic principle is to keep ownership, management and decision-making in the family. In most cases this principle means that management and leadership resources in these firms are seriously limited by the inadequate knowledge of the family in question. Outside expertise in international business is not used by these firms even if the

knowledge within the firm is insufficient. In firms which are not family-owned, outside expertise is recruited if the existing know-how is not enough.

It is interesting to note that large family firms were more active, rapid and successful in their internationalization than large firms which are not family-owned. These firms seem to be capable of successfully combining the strengths of both family and non-family firms. They are accustomed to recruiting outside human resources in the management group and board of directors, thus utilizing the flexibility and rapid reactions of the family firm (Luostarinen 1994, Luostarinen and Hellman 1994).

FIGURE 8

FRAMEWORK FOR THE ROLE OF ORGANIZATIONAL LEARNING
IN THE LATERALLY RIGID DECISION-MAKING AND ACTION PROCESS OF A FIRM

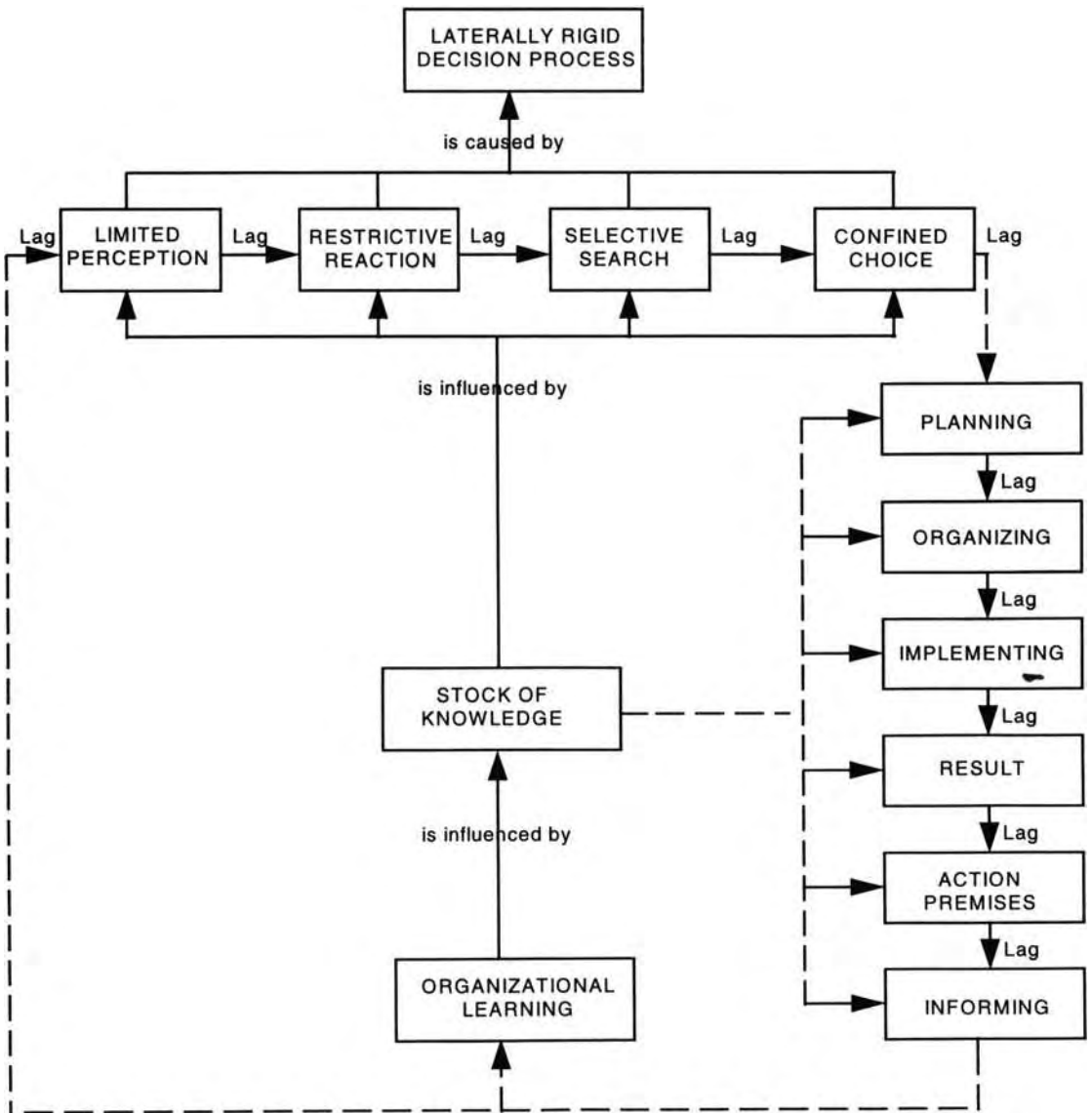

Source: Luostarinen 1979:47.

2.6 Factors explaining success in internationalization

One of the key questions in SMOPECs is how relatively small firms, with limited resources and deficient knowledge of international markets and business, can be successful in the heavily competitive international markets. How can these small- and medium-sized enterprises (SMEs) which only have experience in small scale operations in small domestic markets, succeed in large global markets where huge MNEs seem to be market leaders?

On the basis of excellence-studies within the FIBO programme, it is obvious that we should start answering these questions by first analysing the business areas where the SMEs of SMOPECs cannot be successful internationally and, due to increasing openness, not even domestically. Two such areas have been identified: business areas of MNEs and of enterprises from developing countries (DCEs) (see Figure 9).

FIGURE 9
MNE- AND DCE-AREAS AS BUSINESS AREAS TO AVOID
FOR SMOPEC FIRMS

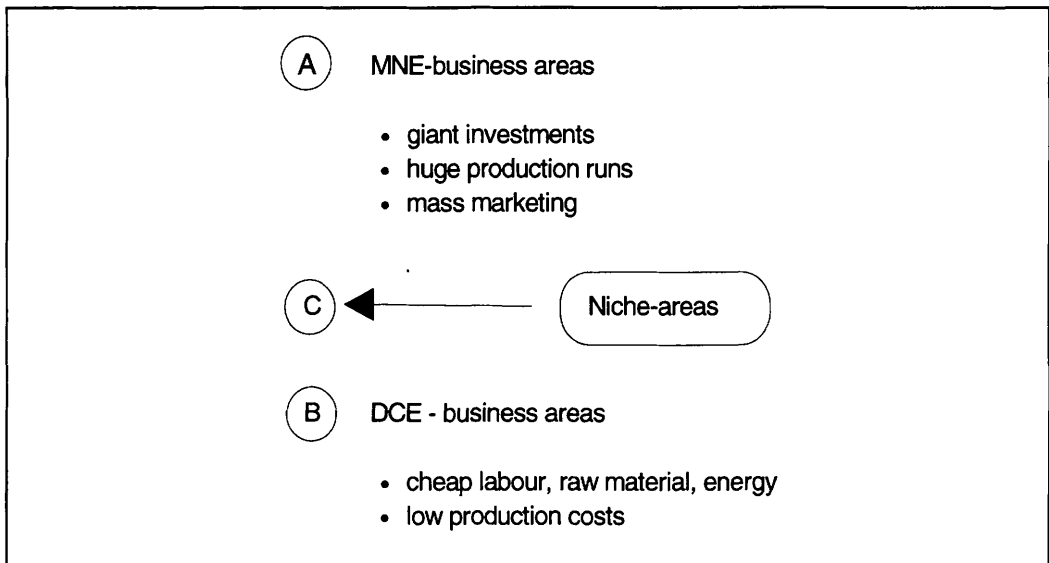

Source: Luostarinen 1989:26.

Finnish SMEs find it very difficult, and in most cases, impossible to successfully compete in the business areas of huge MNEs. This is simply due to the fact that in order to be competitive, Finnish firms should be able to invest large amounts of money in research and development in order to enjoy the advantages of economies of scale in production and to perform expensive mass marketing on a global scale.

In business there are very seldom rules without exceptions. Such is the case also in this matter. If a Finnish firm succeeds in forming a strategic alliance with an MNE it may also be able to succeed in the same business area. However, a Finnish firm should have some special advantages and capabilities to offer to its alliance partner. In most

cases this is an impossible task. That is why these business areas are areas to avoid for most Finnish firms.

The other area, that of developing country enterprises (DCEs), is as difficult as the MNE area. In order to be competitive in this area, Finnish companies should be able to have access to cheap domestic raw materials, low cost labour, low price energy and other cheap domestic production inputs. Again this is very seldom the case. Even the most abundant raw material in Finland, forest/wood, is not cheap, and the labour and energy requirements for profitable and successful competition in the DCE areas are not available for Finnish firms. This is why the major rule is clear: stay out. Again exceptions can be found. If a Finnish firm is not able to compete on the domestic production basis it can enter an equity or non-equity cooperation with a DCE or establish production in the less developed country through subcontracting, licensing, contract manufacturing or a fully-owned production subsidiary and thus gain new advantages. 'If you can't beat them, join them' may also be a good principle in international business.

With the exceptions presented, the basic competitive positioning of Finnish firms indicates that the MNE and DCE business areas are beyond the competitive abilities of the firms. A good question remains: Which are then the competitive business arenas for Finnish firms? Figure 9 gives one answer to this challenging question. It is the area of niche business, which is located between the MNE and DCE business areas. Why would this be the case?

Firstly, the area is relatively safe from competition from MNEs. The volume of sales in this business area is so small that large MNEs are not interested in entering it. Even if they were, they would not be able to utilize their powerful competitive advantages in this area. Large investments are not needed in product or process development, huge production runs are beyond the scope of the business and there is no need for expensive mass marketing.

On the contrary, relatively small (as compared to those usually made by MNEs) R&D investments, flexible small scale production runs and direct focused marketing are the basic competitive elements. This does not mean that no money or investments are needed, but that instead of multibillion R&D, production and marketing investments from total sales of 100-1,000 billion US dollars; the company can survive and prosper with less than 100 million US dollars invested in a business with total global sales of 100-1,000 million US dollars. The slogan is 'it is better to be a global leader in a small business area than a marginal producer in a large business area'.

Secondly, companies operating in the niche area are also relatively safe from companies acting successfully in the DCE business area. This is because that entry barriers are in most cases too high for DCEs. The level of technological knowledge needed for product and process development is too high. The same is true for managerial and marketing know-how. Also the investments needed, even if low compared to the MNE business area, are too high and risky for DCEs. In addition to this, the basic competitive advantages available in DCEs and comparable countries are

more or less useless in this area because it is the uniqueness and special characteristics and not the price of the product which are the critical issues for the sales success.

The niche business area is thus very demanding in a technological, managerial and marketing sense. It is also challenging on an international business side, because domestic demand for these niche-products is, at least in SMOPECs, too low for any reasonable and profitable production. However through globalization the SMEs can finally become mini-MNEs. There can hardly be a greater business challenge than to become a global market leader for a small or newly established national enterprise. The best Finnish success stories are based on meeting this challenge.

When these success stories of a niche area are analysed closer, some important aspects and features are found. Firstly, in order to be able to enter and stay competitive in a niche business through successful internationalization, a company should have at least some competitive edge or excellence, or it should be able to develop and strengthen the excellence during the internationalization process (see Figure 10). On the basis of FIBO studies it has become obvious that different firms have different competitive edges, and that the same company at different points in time may have different advantages to rely on.

FIGURE 10

COMPETITIVE EDGE AS A PREREQUISITE FOR SUCCESSFUL INTERNATIONALIZATION

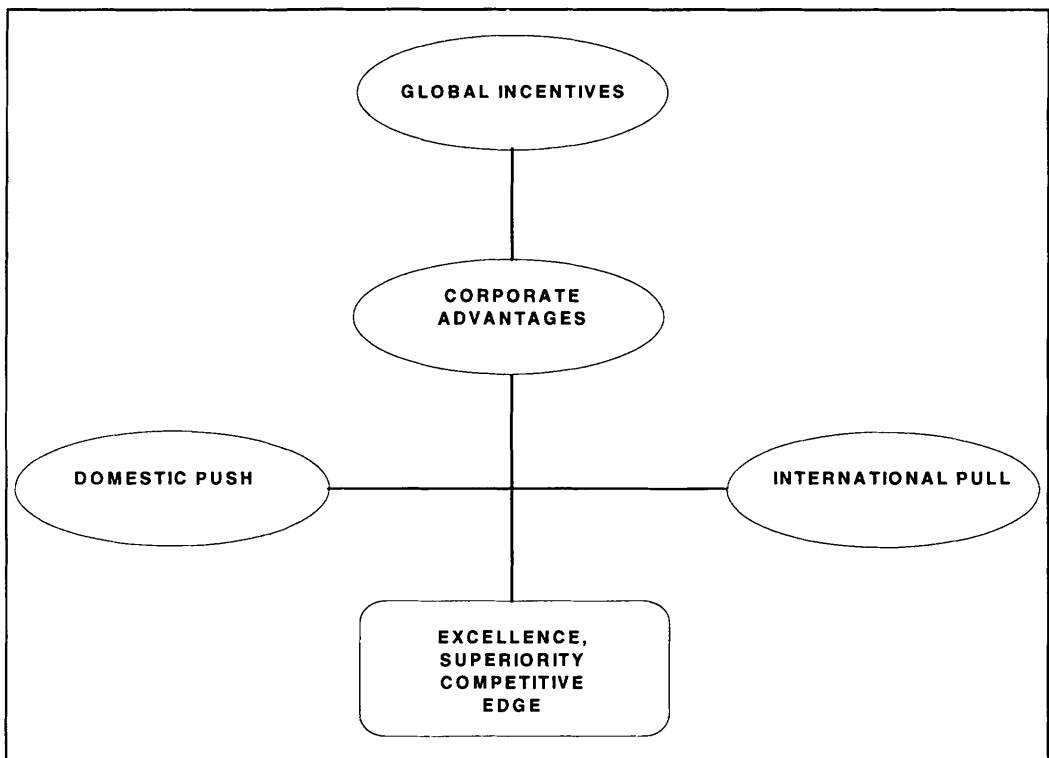

This is why a new concept of the excellence mix or mix of competitive advantages was created (Luostarinen 1986). The purpose of this concept is to indicate

the fact that for successful internationalization it is not enough to have strong domestic push and foreign pull forces but the companies should have some competitive advantage in order to be able to enjoy corporate-specific advantages offered through internationalization. The concept also denotes that every company should, on the basis of strengths, weaknesses, opportunities and threats (SWOT) analysis, carefully select where the company can have advantage and what the mix of advantages should be, simultaneously, but especially successively, in the life-cycle of the product/business.

For Finnish companies, the most typical composition of the excellence mix in the order of importance was: product excellence, production excellence, marketing excellence and finance/information excellence (see Figure 11).

FIGURE 11
COMPONENTS OF THE EXCELLENCE MIX

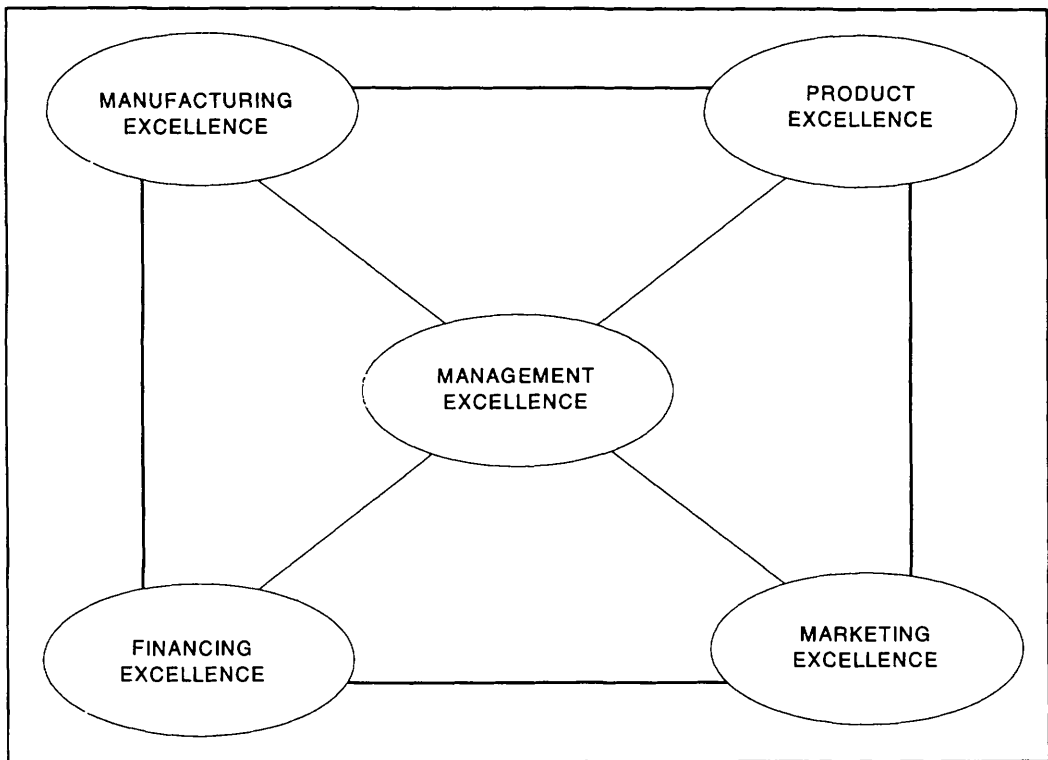

Source: Luostarinen 1989:30.

The most difficult and challenging task for the business manager seems to be the mastering of dynamics: dynamics of competition, dynamics of demand, dynamics of technology development, dynamics of internationalization as a process with a different functional development, etc. There should be a match between the competitive advantages and the company's internal and external action premises. However, because of the existence of dynamics, these action premises are continuously changing and thus the competitive edge which was proper in yesterday's situation might not necessarily be valid in today's or tomorrow's situation. A crucial question is: What is the best competitive edge for the firm today and what should it be in the future?

To answer this question a new concept of profit cycle was developed (Luostarinen 1989). The purpose was to try to analyse the logic of the development and use of competitive advantages in successfully internationalizing Finnish firms. A kind of dynamic mainstream pattern of competitive advantages was emerging. The major way for companies to enter the profit cycle was through product excellence (see Figure 12). The firms had been able to develop products with unique characteristics which satisfied the needs of selected customers in a better way than any of the competing products. Through this product excellence companies became the product leaders in the international markets. The major advantage of the product leadership position was to be found in its impact on company pricing strategy. With the best product in a niche business area a company was able to use a skimming price strategy because the match between the unique characteristics of the product and the crucial needs of the customers was more important for the customers than price. If we take it for granted that the cost level of a firm is about the same as that of its major rivals, then the company with the highest prices becomes a profit leader and the company has entered the profit cycle. The question of how to remain there is then of utmost interest and importance.

FIGURE 12
ONION-LIKE PROFIT CYCLE THEORY

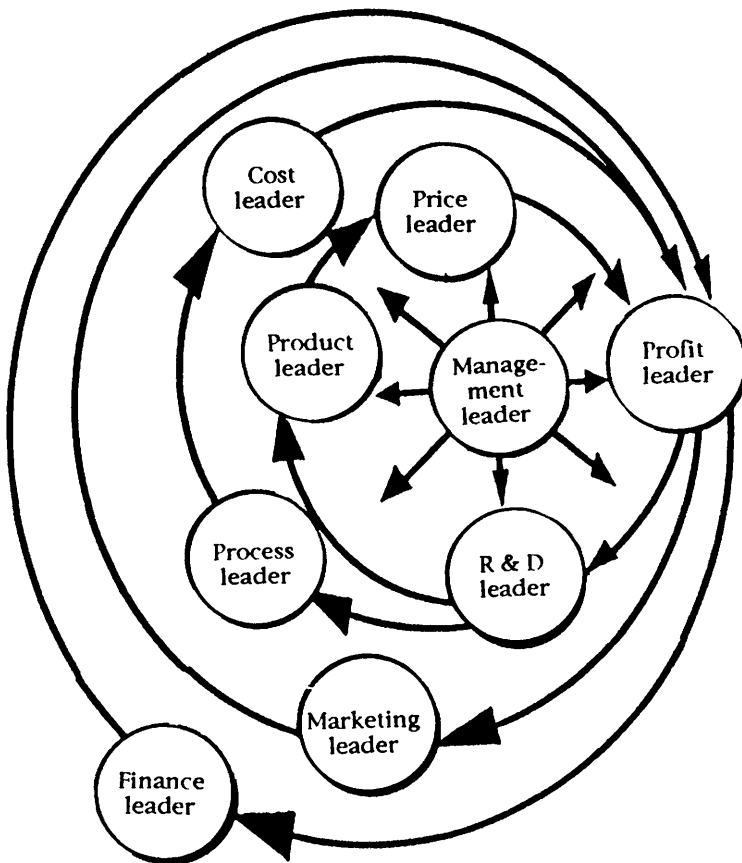

Source: Luostarinen 1989:31.

Through the excellence project, two different groups of companies have been identified: fixed stars and falling stars. Fixed stars are companies which have been able to shine brightly and continuously on the business sky, and falling stars are firms which have disappeared from the sky as rapidly as they had appeared on it.

The most powerful factor for these companies seems to be management. It is the duty of management to be responsible for the continuous development of the competitive ability of a firm, that is why in Figures 11 and 12, management is located in the middle to clearly symbolize this fact. The most typical falling stars in Finland have been those companies in which the management has not been able to understand the importance of dynamics and the devastating forces behind it. The companies were able to become product leaders. However, the management of the firms did not realize the erosive power of competition over time and the necessity of continuous R&D investments until their rivals had deeply penetrated the market with even better (and cheaper) competing products. It became too late to react successfully and the companies were hurled out of the profit orbit. This is why R&D as an umbilical cord between profit leadership and product leadership or process leadership is crucial for a continuous stay inside the profit cycle.

It is typical that management of the fixed stars are able to realize that one advantage is not always enough at a certain point of time and especially not over time. That is why management faces a double challenge in considering what is the proper simultaneous combination of areas of excellence and the profitable chain of successive areas of excellence for a certain product or business. The most typical pattern seems to be the following chain of areas of excellence: product leadership, production leadership, marketing leadership and finance/information leadership. A company enters the profit cycle through an excellent product innovation and becomes a product, price and profit leader. Through profit leadership the company is able to invest more money in product development and to remain a product, price, profit and R&D leader. However, it is almost impossible for management to be continuously successful in the development of new products. Thus management may decide to allocate part of the R&D funds to the development of production technology in order to become a cost leader. Even if the company faces competing products with similar prices in the market, it is able to remain a profit leader because it is able to produce at a lower cost than competing firms. The counter strategies and imitative moves of the competitors to reduce their costs with process development, force the company to strengthen its competitive position by becoming a marketing leader, e.g., by investing an exceptional amount of money in monopolizing the best marketing channels, by preparing excellent marketing campaigns, etc. This way the company is able to stay a fixed star within the profit cycle. The difficulty is to know what is the area of excellence – the competitive edge – with which to enter the profit cycle, how long this area of excellence can be utilized, when to develop the next area of excellence and what these succeeding areas of excellence should be.

The examples mentioned above were all cases for the successive development of areas of excellence (chain of excellence). However, a firm may need more than just one area of excellence at the same time. Competitive Strategy developed by Michael E.

Porter in 1980 includes two important strategies to outperform competitors in an industry: cost leadership and differentiation. However, according to Finnish experience, even if these two may be alternative strategies exclusive of each other, they can also be used simultaneously. This double excellence mix makes the competitive position of the company exceptionally strong because it operates in the market simultaneously with the highest prices and the lowest costs.

2.7 Job and wealth creation through internationalization

On the basis of empirical evidence (Luostarinen 1978a and Luostarinen, Korhonen et al. 1994), globalization seems to contribute to company growth, profitability and continuity. Consequently, it can be argued that globalization also correlates positively with job and wealth creation. The statistical data shows that the shares of employment and turnover in SMEs within all enterprises have grown significantly and rapidly. For example, SMEs employing less than 200 persons made up 0.1 per cent more of the number of firms in 1991 than in 1986 (99.4% – 99.5%), while during the same period the importance of the same firms measured by employment increased as much as 5.4 per cent (47.2% – 52.6%) and measured by the share of total turnover by 5.7 per cent (41.4% – 47.1%). Generally accepted is the fact that new jobs in Finland can be created in SMEs, whereas large firms continue to reduce their workforce (Luostarinen, Korhonen et al. 1994).

III THE ROLE OF FINNISH GOVERNMENT IN THE INTERNATIONALIZATION PROCESS

The governmental subsidies for companies, banks and agriculture are topics of current interest in Finland. In the latest settlement, governmental support is too broad and complicated. It consists of 170 industrial subsidies, 94 taxation subsidies, more than 70 clauses related to governmental support and over one hundred related to other subsidies. In 1992, the amount for subsidies in the state budget was about FIM 60 billion. The amount for industrial subsidies was FIM 6 billion and the corresponding figure for agriculture was FIM 9 billion. Given this, drastic measures are to be taken in order to cut the level of the subsidies in the near future.

The amount of government support of companies has doubled in a couple of years, even if the aim of the Ministry of Trade and Industry is to stop supporting companies directly in the near future. According to the former Minister of Trade and Industry, it seems to take three to five years before the Ministry is able to cut direct company support. This is due to the current recession and its negative effects, especially on companies operating in the home market. In the near future the remaining support will be mainly allocated to the development of R&D, marketing and managerial know-how. The following lists show the current proposal for the allocation of public subsidies.

According to the state budget proposal in 1993, the Ministry of Trade and Industry specified the following objectives for export promotion:

1. To support structural and geographical development of export;
2. To adapt the export promotion forms to the continuously changing European business environment;
3. To develop the activities of trade commissioners together with the Finnish Foreign Trade Association.

The budget proposal also emphasizes that appropriations will be allocated especially to promote export activities of the SMEs.

The business plan 1992-1995 of the Export Promotion Division under the Ministry of Trade and Industry says that:

1. Full utilization of the market potential provided by the EC and EFTA-countries will be one of the most important parts of export promotion in the near future;
2. Export promotion activities will be especially allocated to environment technology, information technology, transportation, the construction

- industry, material technology, process technology, production technology and the engineering industry;
3. Export cooperation of SMEs will be developed by increasing information services as well as assistance, and by developing cooperation between companies in general;
 4. Subsidies will be allocated in larger quantities for the development of export promotion by industries.

Obviously companies at different stages of internationalization have different needs, problems and challenges related to internationalization development. Against this background it is interesting to study how well different governmental agencies have been able to develop promotional toolboxes to match the diversified needs of internationalizing firms.

One of the challenges seems to be how to deal with the total process of internationalization. It is customary that outward internationalization is a clear and understandable target for governmental promotional measures in Finland as well as in many other countries. Strategic alliances and especially network operations have also gained favour. The problem area is inward internationalization. Imports, technology transfer operations and other inward modes are not usually included in the governmental promotional packages. In too many cases the internationalization process is not yet fully understood as a two-way street and on a holistic basis as described previously.

Exporting and other outward operations are largely seen as positive things but importing and other inward operations are seen as negative, sometimes almost unpatriotic ways of doing business. However, it is roughly estimated that about half of Finnish imports serve as inputs for Finnish exports. Thus the export competitiveness of this sector largely depends on its ability to import on a competitive basis. Perhaps only about 25-30% of total imports compete directly with existing Finnish production and supply. Even for this part of imports the only reasonable word is 'welcome'. Is it not better that Finnish firms can meet the competition 'safely' on the domestic market where their competitive ability should be the best possible? If Finnish companies are successful in this competition there is a reasonable basis for entering international markets where the same competitors are to be met. Obviously there is every reason to reconsider the attitudes and policies towards inward operations and to also selectively include them in promotional programmes.

The second challenge comes from the operation strategy options. In many cases the traditional and well-known operation modes are well accepted as, for example, the title 'export promotion' denotes. However, some companies may be in a position where modes other than traditional modes offer much better possibilities. The key question is: Why not also give assistance to those companies which are using franchising, co-production and other rare but innovative modes as their major operation strategy abroad?

The third challenge is dealing with the level and contents of assistance. It is a well-known fact that before starting really 'heavy' internationalization moves a company should have a strategy of how to do it, i.e. to be able to answer the questions 'what, where, how and when'. In addition to tactical and operational level promotion, the governmental agencies should also be able to help a company to make strategic decisions. Naturally, trade officers and commercial attaches, for example, are promoting their own area of location, but when doing so they should help the company's strategic decision-making by urging them to enter easier, closer markets first if they see that the accumulated knowledge and experience or financial standing are not yet strong enough to enter the more difficult markets. Another example is the area-approaching strategy. Local Finnish trade promoters should have the abilities to help a company formulate a strategy for a whole area (EU, NAFTA, etc.) not only for a country where they are located. So the core of this challenge is to be able to match the promotional tools with the stage of internationalization and level of competence of the firm in question.

The fourth challenge, also identified in the 'Globalization of SMEs' study (Luostarinen, Korhonen et al. 1994), is the removal of barriers before using incentives. The message from firms studied was that the existence of different types of barriers discourages, more than incentives are able to encourage, the start and/or development of internationalization. One of the most powerful tools to promote internationalization may, in this case, be to simply abolish these barriers.

Based on the theoretical and empirical findings and on the analysis of challenges presented, some general characteristics for the so-called best practice policy are suggested.

1. The Government should remove barriers to internationalization first, and only after that, if needed, use incentives for internationalization. The Government should remove barriers to internationalization, rather than help an endless queue of companies to jump over them one by one.
2. The best practice policy should be based on the real needs of firms. Before establishing the supply side of internationalization promotion, the demand side, i.e., the real needs of internationalizing firms, should be studied in order to avoid the malpractice of giving a large share of governmental promotion to large profitable companies or their seemingly small and medium-sized units. The findings of the study could then be taken as a basis for the governmental supply side of internationalization promotion. So far, little attention has been paid to the customer-oriented approach which emphasizes the realization of customers' needs.
3. There have to exist supporting organizations which concentrate on the specific problems of companies performing at each stage of internationalization. In Finland, the real needs of companies at each stage of their internationalization process have not yet been studied and it is therefore difficult to estimate the gap. The needs analysis could reveal, for example, whether the money used for promotion corresponds with the ratios presented in the theory of internationalization. It is said that if one unit of money is needed for product

development and two units for process development then at least four to six units are necessary for internationalization development. It is highly likely that the amount of money needed for internationalization development is badly underestimated.

4. The best practice policy should be flexible. No strict standards for internationalization promotion should be formed, because internationalization is a complex phenomenon including inward, outward and cooperative operation modes. According to the empirical data, it can be said that companies have different kinds of needs for internationalization support depending on their field of business, ownership, stage of internationalization and incentives to internationalize. In order to be able to take the real needs of companies into account, the best practice policy should be a project or programme type by nature, instead of being fixed on a long-term basis, as is the usual case in Finland. In addition to flexibility, goal-oriented projects or programmes facilitate the measuring of the exact costs and achievements of a certain policy.
5. The best practice policy has to be continuously updated. It has to take into account the rapid changes in the external environment of companies and react to them quickly. One example is that Eastern European companies are rapidly becoming serious competitors for Finnish companies in business areas where the low cost of labour, raw materials and other production costs are competitive advantages. Eastern Europe can be seen either as a threat or a great opportunity depending on the companies' ability to take advantage of the current situation. The governmental supporting organizations should react rapidly to the new needs of companies and start promoting, for example, subcontracting, contract manufacturing, joint ventures and cooperation in Eastern Europe.
6. The best practice policy has to be based on a holistic concept of internationalization. As the term 'export promotion' indicates, it concentrates on the promotion of traditional export. However, companies use altogether 24 types of outward operation modes, 19 types of inward modes and 11 types of cooperative operation modes (Luostarinen 1979). Therefore, in addition to export promotion, the promotions of other outward operations (Luostarinen 1991 and 1994), as well as inward and cooperative modes, are needed. The success of outward internationalization may be heavily influenced by the success of preceding and simultaneous inward operations. In the same way, cooperation, networking and strategic alliances are keywords in today's global business, especially among SMEs. To sum up, firstly, promotion of a holistic internationalization process, which includes inward, outward and cooperative operation modes, is needed (see Tables A2, A3 and A4 in Appendix). Secondly, the focus of internationalization promotion should not only be on the operational level but also on the strategic level (see Tables A2 and A3 in Appendix). Thirdly, internationalization promotion should cover not only industrial companies but also service companies (see Table A4 in Appendix), which today get hardly any support (Luostarinen, Korhonen et al. 1994, Pietikäinen and Tynnilä 1994).

The use of the best practice policy characterized above should lead to an ideal situation where some of the supporting systems and/or organizations and funds are no longer needed.

IV RELEVANCE OF FINNISH EXPERIENCE FOR OTHER COUNTRIES

Very seldom is there just one best way of doing things. This is especially so if the external environmental variables and internal action premises (resources) differ for different firms and promotional agencies. Usually this is the case, especially when we talk about different countries. This is why the relevance for other countries of Finnish experiences for the development of promotional programmes of internationalization and for the development of firm strategies for internationalization is not an easy question. However, based on existing evidence and the author's own personal experience three cases are presented where the relevance of Finnish experiences is perhaps the highest:

1. Small and open economies (SMOPECs);
2. Eastern and Central European countries (economies in transition);
3. Developing countries.

4.1 SMOPECs

Finland is a very typical and representative SMOPEC with a population of 5 million and with the bilateral and multilateral trade agreements (GATT 1951, Finn-EFTA 1961, EEC 1973, COMECON 1974-1975, EEA 1993 and application to the EU in 1994) Finland may be used as a benchmark at least by those SMOPECs where the internationalization processes at different levels are not yet so much developed.

As presented earlier, when a small nation opens its borders for international trade, the push and pull forces for internationalization get considerably stronger. That is when the slogans 'internationalize or die' and 'globalize or die' get meaningful and understandable. Increased openness is thus either a blessing or a curse depending on the behaviour of the nation and its firms. If companies are passive, increasing import will threaten their position and even survival. If companies actively utilize the newly opened possibilities, the openness acts as a positive factor.

According to existing studies, it is obvious that the stage pattern is more valid for firms in SMOPECs than for firms with large and less open domestic markets. Firms and especially SMEs in these markets have enough domestic growth opportunities, so there is no pressure for them to internationalize their operations. Only if the expected profits gained from foreign markets seem to be considerably higher than in their domestic markets might they be willing to internationalize their operations. So, we can argue that in SMOPECs, firms internationalize principally due to the powerful push forces, and in large countries they internationalize mainly due to the pull forces. However, as noticed in Finland, in the later stages of the country's and industries' internationalization, the pull forces play an ever stronger role. This means that companies move from a defensive type of internationalization to a more active and aggressive type of internationalization.

4.2 Economies in transition

Economies in transition have enormous challenges and problems to be solved. Some of those are: how to diversify the industrial and export structure successfully and how to get companies moved to different and higher stages of internationalization profitably. Finland is one of the countries which has faced similar problems and has relatively recently been able to find ways to solve these problems. So, Finnish patterns for internationalization and public promotional policies for internationalization may be more easily adjusted to the economies in transition than patterns and policies from the countries where the conditions are and have been very different. The close location, historical connections and good relations to these countries during the communist regime and Finland's present gateway position act as additional advantages when Finnish experiences are transferred to these countries.

Finland has already been transferring these experiences through consulting, management education and university cooperation to the economies in transition, especially to Russia and Estonia. For its own part, the Helsinki School of Economics has participated in this work through various programmes (International BBA and MBA programmes), departments (International Business Department, Management Department), Small Business Center, Management Training Center and the Central and Eastern European Programme (CEEP).

4.3 Developing countries

Developing countries are and have been partly facing the same problems as the Eastern and Central European economies in transition. Thus Finnish experiences and models are useful for their purposes. Not too long ago Finnish industries were using labour intensive methods. These methods are still remembered by experts who can act as transfer agents when these skills and methodologies are needed for the internationalization development of DCEs. It is understandable that the experiences have to be adapted to the local needs and conditions. This adaptation task is partly the responsibility of the transferrers and partly by transferees.

It has become evident that a holistic internationalization pattern is a useful design not only for economies in transition but also for developing countries. Similar to the Finnish experiences, these countries should strongly pay attention to inward internationalization. Foreign technology, management and marketing know-how is needed. However, some of the developing countries such as Tanzania, have relied very little on technology transfer from abroad. According to a recent interview study of 217 Tanzanian industrial firms, only four firms held a foreign licence and ten firms had a foreign assistance (know-how) agreement. Most assistance contracts were technical. Only two firms held a management contract and one a marketing contract (Luostarinen, Blanc et al. 1994). It is of great importance to get to know the reasons for this marginal involvement in the inward technology transfer by Tanzanian firms. In some cases, import of foreign raw materials and components is necessary for the gradual development of export capabilities. In order to be able to import, these countries must be

able to export, and in this way earn enough foreign currency to pay for imports. Finally, cooperation modes are needed to strengthen the internationalization process of firms. Strategic alliances are needed not only with firms from developed countries but especially with firms from other developing countries and countries in transition.

Finland has not been too active in cooperating with developing countries in this area. However, one positive example can be mentioned: PRODEC, the Development Cooperation Programme at the Helsinki School of Economics, has been working for the development of the internationalization capabilities of firms and governmental agencies in developing countries since 1968. PRODEC offers training in the fields of import and project management and also in the areas of export management and promotion as well as cooperation between firms from developing countries. Thus, PRODEC is transferring the knowledge and skills related with a holistic internationalization process of the firm.

V INTERNATIONALIZATION OF FINNISH FIRMS AND DEVELOPING COUNTRIES

Only a very small proportion of Finnish industrial firms have business transactions with firms in developing countries. As to inward operations in 1990, only six out of a total of 593 industrial companies studied had machinery and spare parts imported from developing countries (Asia), 60 companies had raw material and component imports (Asia, South America) and 32 had imports of finished products mostly from Asian countries. African and Middle Eastern countries were mentioned only ten times as sources of imports. No other inward operations had taken place from developing countries. It is interesting to note that the majority of importers consisted of small industrial firms followed by large and medium-sized firms.

As to outward operations, 72 firms had indirect exports (domestic middlemen) to developing countries, 63 direct exports (foreign middlemen) and 67 their own exports (without middlemen). Again the largest group of exporters consisted of small firms, followed by medium-sized and then large firms. Eight firms had contract manufacturing operations in Asia and one in South America. Twenty-four companies had turn-key projects and nine partial projects in developing countries. Eight companies had used licensing and nine technical know-how agreements. Only four firms had been involved in the transfer of management and marketing know-how.

The amount of Finnish direct investment in developing countries by the 593 companies studied was small. Only 35 marketing and sales units, and 19 assembly or manufacturing units were established before 1990, and most of them in Asian countries and the smallest number in African countries.

As to the cooperation agreements between the Finnish firms and firms located in developing countries, nine out of 16 agreements were with Asian companies.

Is this low international business involvement in developing countries due to the lack of interest, lack of knowledge, disappointments/losses experienced in earlier operations in these countries or the lack of initiatives from these countries? Obviously all of these are valid reasons for a low commitment to doing business with firms of developing countries. However, different firms are in different positions.

It is evident that the largest Finnish internationalizers, which are active in major European, North American, Australian and developed Asian markets, are also dealing with developing countries by using different operation strategies. To a large extent, also highly globalized small firms have expanded their operations to developing countries. Some of them have even entered developing countries more strongly than developed countries. However, among both large and small globalized firms, some had no

operations at all with developing countries. This seemed to be due to the nature of the products produced and sold, either the technology was too sophisticated or owing to some other characteristics there was no, or a very weak, demand for the product in developing countries.

Another group of companies, which had no operations with the developing country companies, were those at the starting or developmental stage of their internationalization process. Most of them had penetrated the neighbouring Scandinavian markets and some German and British markets. For them the central part of market strategy seemed to be to enter the developed markets first and perhaps then the markets in developing countries. However, it is interesting to note that in many cases also Eastern and Central European markets were entered first.

The firms which had advanced to developed Asian markets seem to be a special case. Through these Asian operations they seemed to expand also to the less developed Asian countries (Hong Kong/China, Singapore/Indonesia) before entering, for example, the North American or Australian markets.

Further it is of interest to notice that most of those few small or large firms active in the African continent utilized the financial possibilities offered by Finnida, Finfund or sometimes by equivalent foreign or international agencies. Without this seed money many of these companies would obviously not have entered these operations.

The major explanation for not being involved in developing countries is to be found in the business distance, which is the combination of geographical, cultural and economic distances (Luostarinen 1978, 1979). Firstly, African, Asian and Latin-American developing countries are located physically far away from Finland. Due to transportation, travelling and communication costs, companies prefer to enter closer markets first. Secondly, many of the developing countries are considered culturally distant by Finnish firms. Thus they are also perceived to be markets with high uncertainty and risks. Due to the lack of a colonial past, the uncertainties and risks in these developing countries are perceived to be markedly larger than in countries with historical connections. Thirdly, developing countries are also different economically from Finland, even if, as mentioned earlier, Finland has recently solved similar economic problems as those which developing countries are facing today. Due to the joint effect of these three distances, firms usually have a high degree of lateral rigidity concerning these distant countries and for this reason they prefer to enter closer markets first.

VI FUTURE CHALLENGES FOR INTERNATIONALIZING FINNISH FIRMS

At the same time as globalization is becoming more and more necessary, even for smaller Finnish companies, the global business environment is going through major changes. There is an evident continuously strengthening globalization trend throughout the world, which becomes apparent from the increasing integration, free-trade and custom areas in all the main continents.

As to integration development, the most essential question is: How are Finnish firms going to meet the challenge of the European Union? Most firms do not realize that staying outside the EU would be a disaster for them. This is due to Finland's participation in the European Economic Area (EEA) which is perceived to guarantee almost similar advantages as EU membership. Another fact is that most of the large Finnish MNEs and smaller mini-MNEs are already inside the area of EU through established manufacturing units. So, they do not feel threatened if Finland would stay outside. Obviously many challenges remain for the large, medium-sized and small firms which have not yet established themselves within the EU (see, e.g., Lehtinen and Vallius 1993).

In addition to the many opportunities of EU membership, one particular threat has been pointed out: the fear of losing the advantages enjoyed in the Russian, Baltic and Eastern European trade. Due to the EU's common external tariffs for third countries, Finnish firms may face higher duties in exports and imports with the economies in transition in Eastern and Central Europe.

The major impacts of European integration on Finnish firms are:

1. Many firms have already become insiders by establishing manufacturing units inside the EU (in 1992 the number of these subsidiaries was 422 or 40% of the total number of Finnish production units abroad);
2. Many firms have realized the possibilities offered by a larger internal market by establishing sales and marketing subsidiaries within the EU (in 1992 the number of these subsidiaries was 964 or 46% of the total number of Finnish non-production units abroad);
3. Some of the firms accelerated the establishment process the time of uncertainty of EU membership;
4. Companies in earlier closed sectors perceive competition will become stronger in the domestic market. However, open sector firms do not see any greater competitive threats at home due to the integration.

As mentioned earlier, the slogan in the 1990s is 'globalize or die'. It is evident that the major challenge is not necessarily how to 'Europeanize' but how to globalize through entering markets in other continents. Many of the forces behind internationalization are global by nature. Thus it is not easy to specify whether it is the European integration or the global changes which have been and are acting as trigger signals for the internationalization development of firms.

The most acute threat and challenge for Finnish SMEs does not come, however, from the integration development, but from Eastern European companies. They are rapidly developing into serious competitors for Nordic and Western European firms in all those business areas where low costs of labour, raw material and other production inputs have a crucial role as competitive advantages. Because Eastern European companies are overwhelming in price competitiveness, Finnish firms must have strong technology or a know-how based competitive advantage over these new rivals, or they must establish business or cooperative relations with them. Subcontracting, contract manufacturing, contractual and equity joint ventures are examples of the modes which could be used. If nothing is done or the cooperation is not started quickly enough, Eastern European companies will start to compete heavily both in the Finnish and export markets, and/or other Nordic or Western European competitors will most probably use the same options and get the best partner companies from Eastern Europe.

The establishment of a Free Trade Zone (FTZ) along the Finnish-Russian border would offer promising new possibilities in utilizing different inward, outward and cooperative operation modes for the benefit of both countries. Due to the Russian transformation, Finland's membership in the European Union and Finland's position as a gateway between East and West, the establishment of a FTZ would result in growth of trade and investment and technology transfer between these two countries. Finland's new geopolitical situation and EU membership are bound to strengthen its gateway role as it will become the primary border between Russia and the EU. A border FTZ may be seen by EU companies as a convenient and low risk entry point to Russia. Already about 45 foreign and multinational companies have subsidiaries in Finland and use them as strategic springboards to their operations in Russia, the Baltic States and/or other Eastern and Central European countries in transition. On the other hand, Russian firms operating in a border FTZ may find an easier access to EU markets, being perceived by EU customers as more reliable, advanced and 'Western' (Luostarinen, Welch and Welch 1994).

Promising possibilities exist also in the Baltic States, especially in Estonia, where Finnish firms have established more subsidiary and joint-venture units than in any other country (3,500 registered firms of which 1,854 seemed to be active in 1994 – source: FIBO-data base).

The greatest of the future challenges is, however, the demand for global activities, i.e., the globalization of Finnish firms. This is actually a kind of paradox. Finnish companies by international standards are small. Smallness usually means limited resources, early stages of growth, little experience with internationalization and global markets and a relative weak financial standing. Still these small companies

should be able to meet the largest geographical challenge by globalizing their operations, i.e., they should enter markets in all major continents, and in some cases do it fast. As a management issue this is certainly one of the greatest and most difficult challenges any business can ever meet.

REFERENCES

- Aharoni, Y. (1966) *The Foreign Investment Decision Process*. Boston: Harvard University Press.
- Avikainen, T. and Harra, K. (1992) *Internationalization of Medium-Sized Finnish Industrial Firms*. Helsinki: FIBO Report, Helsinki School of Economics.
- Bellak, C. and Luostarinen, R. (1994) *Foreign Direct Investment of Small and Open Economies -Case of Austria and Finland*. Helsinki: CIBR Research Reports Series X-1, Helsinki School of Economics.
- Bilkey, W. J. and Tesar, G. (1977) The Export Behavior of Smaller Wisconsin Manufacturing firms. *Journal of International Business Studies*, Vol. 8, Spring/Summer.
- Calof, J. L. (1991) *The Internationalization Process: An Examination of Mode Change, Mode Choice and Performance*. Doctoral Dissertation, University of Western Ontario.
- Cavusgil, S. T. (1984) Organizational Characteristics Associated with Export Activity. *Journal of Management Studies*, Vol. 21, No. 1, Jan.
- Cyert, R. and March, J. (1963) *A Behavioral Theory of the Firm*. Englewood Cliffs (N.J.).
- Denis, J.-E. and Depelteau, D. (1985) Market Knowledge, Diversification and Export Expansion. *Journal of International Business Studies*, Vol. 16, Fall.
- Hedlund, G. and Kverneland Å. (1983) *Are Establishments and Growth Strategies for Foreign Markets Changing?: The Case of Swedish Investment in Japan*. Stockholm: Research Papers, Stockholm School of Economics.
- Hellman, H. (1993) *Internationalization of Family Firms*. Helsinki: FIBO (Master's Thesis), Helsinki School of Economics.
- Hentola, H. (1994) *Foreign Sales Subsidiaries and Their Role Within the Internationalization of the Company – a Study of the Finnish Manufacturing Firms*. Helsinki: CIBR Research Reports Series X-2, Helsinki School of Economics.
- Huttunen, S. and Posti, S. *Internationalization of Large Finnish Industrial Firms*. Helsinki: FIBO Report, Helsinki School of Economics
- Häkkinen, T. (1994) *Divestments of Foreign Subsidiaries of Finnish Manufacturing Companies*. Helsinki: CIBR Research Reports Series X-3, Helsinki School of Economics.
- Janatuinen, T. (1984) *Internationalization of the High Tech Company – The Case of Vaisala 1936-1986*. Helsinki: FIBO Publications, Helsinki School of Economics.
- Johanson, J. and Vahlne, J.-E. (1977) The Internationalization Process of the Firm. *Journal of International Business Studies*, Vol. 8, Spring/Summer.

- Johanson, J. and Vahlne, J-E. (1990) The Mechanism of Internationalization. *International Marketing Review*, Vol. 7, No. 4.
- Johanson, J. and Wiedersheim-Paul, F. (1975) The Internationalization of the Firm – Four Swedish Cases. *Journal of Management Studies*, Vol. 12, No. 3.
- Joynt, P. (1981) An Empirical Study of Norwegian Export Behavior. *Skriftserie*, No. 1.
- Juul, M. and Walters, P. (1987) The Internationalization of Norwegian Firms – A Study of the U.K. Experience. *International Management Review*, Vol. 27, No.1.
- Kosonen, H. (1990) *System Sales as an International Business Strategy of Industrial Companies*. Helsinki: Helsinki School of Economics.
- Lehtinen, U. and Vallius, R. (1993) *Internationalization Strategies of the Firms and European Integration* (in Finnish). Tampere: Federation of Finnish Metal Industries.
- Luostarinen, R. (1970) *Foreign Operations of the Firm*. 1st Edition, Helsinki.
- Luostarinen, R. (1977) *Lateral Rigidity in International Business Decision-Making*. Helsinki: FIBO Working Paper, 1977/1, Helsinki School of Economics.
- Luostarinen, R. (1978a) *International Business Operations of Finnish Firms* (in Finnish). Helsinki: FIBO Publications, No. 9 Helsinki School of Economics.
- Luostarinen, R. (1978b) *Internationalization Process of the Firm – Different Research Approaches*. Helsinki: FIBO Working Paper, 1978/1, Helsinki School of Economics.
- Luostarinen, R.(1978c) *The Impact of Physical, Cultural and Economic Distance on the Geographical Structure of the Internationalization Pattern of the Firm*. Helsinki: FIBO Working Paper 1978/2, Helsinki School of Economics.
- Luostarinen R. (1979) Internationalization of the Firm. 1st Edition, Doctoral Dissertation, Helsinki: Helsinki School of Economics, (3rd Edition 1989)
- Luostarinen, R. (1980) *Internationalization – A Major Growth Strategy of Finnish Firms in 1980s* (in Finnish). Helsinki: System Group Publications, A-1.
- Luostarinen, R. (1982) Internationalization of Finnish Firms; Motives, Strategies, Problems and Challenges (in Finnish). *Finnish Economic Journal*, No. 2.
- Luostarinen, R. (1986) Internationalization of the Firm. Lecturing Notes, Helsinki: Helsinki School of Economics.
- Luostarinen, R. (1991) Development of Strategic Thinking in International Business: The Case of Finland. *Arenas of Strategic Thinking*, ed. by Juha Näsi, Helsinki: Foundation for Economic Education.
- Luostarinen, R. (1993) Promotion of Private Sector Internationalization in Developing Countries – A Holistic Approach. A paper presented in OECD, Paris, April 1-2/DAC-meeting, September.
- Luostarinen, R. (1994) Internationalization of Family Enterprises. Helsinki: CIBR Working Papers Series Z-1, Helsinki School of Economics.
- Luostarinen, R., Blanc, X, Karlo K. and Al-Obaidi, Z. (1994) *Development and Growth of Industrial Enterprises in Tanzania*. World Bank Regional Program on

- Enterprise Development in Africa, Helsinki: CIBR, Helsinki School of Economics.)
- Luostarinen, R. and Hellman, H. (1994) *The International Process and Strategies of Finnish Family Firms*. Helsinki: CIBR Research Papers Series Y-1, Helsinki School of Economics
- Luostarinen, R., Korhonen, H., Jokinen, J. and Pelkonen, T. (1994) *Globalization and SME – OECD Project*. Helsinki: Ministry of Trade and Industry, Studies and Reports, 59/1994.
- Luostarinen, R. and Pulkkinen, T. (1991) *International Business Education in European Universities in 1990*. European International Business Association, Helsinki: School of Economics.
- Luostarinen, R., Welch D. and Welch L. (1994) *Technology-Parks and Free Trade Zones*. Mikkeli: Avain Sektori Journal No. 2, Small Business Center.
- Luostarinen, R. and Welch, L. (1990) *International Business Operations*. Helsinki.
- Piercy, N. (1981) Company Internationalisation: Active and Reactive Exporting. *European Journal of Marketing*, Vol. 15, No. 3
- Pietikäinen, M. and Tynnilä, P. (1994) *Obstacles to and Strategies of the Internationalization of Finnish Service Companies*. Helsinki: FIBO Research Reports, No. 39, Helsinki School of Economics.
- Porter, M. E. (1980) *Competitive Strategy*. New York: The Free Press.
- Turnbull, P. (1985) *Internationalization of the Firm – A Stages Process or Not?* Paper presented at the conference on Export Expansion and Market Entry Modes, October 15-16, Halifax: Dalhousie University.
- Valtonen, M. (1992) *Internationalization of Small Finnish Industrial Firms*. Helsinki: FIBO Report, Helsinki School of Economics.
- Welch, L. and Luostarinen, R. (1988) Internationalization: Evolution of a Concept. *Journal of General Management*, Vol. 14, No.2, Winter.
- Welch, L. and Luostarinen, R. (1993) Inward-Outward Connections in Internationalization. *Journal of International Marketing*, Vol. 1, No. 1.
- Welch, L. and Wiedersheim-Paul, F. (1980) Domestic Expansion: Internationalization at Home. *Essays in International Business*, No. 2, December.
- Wilkins, M. (1970) *The Emergence of Multinational Enterprise*. Cambridge: Harvard University Press.
- Wilkins, M. (1974) *The Maturing of Multinational Enterprise*. Cambridge: Harvard University Press.
- Yaprak, A. (1985) An Empirical Study of the Differences Between Small Exporting and Non-Exporting US Firms. *International Marketing Review*, Vol. 2, No. 2.

APPENDIX

Figures A1 – A2

Tables A1 – A4

FIGURE A1

FACTORS AFFECTING THE INTERNATIONALIZATION PROCESS OF FINNISH INDUSTRIAL COMPANIES

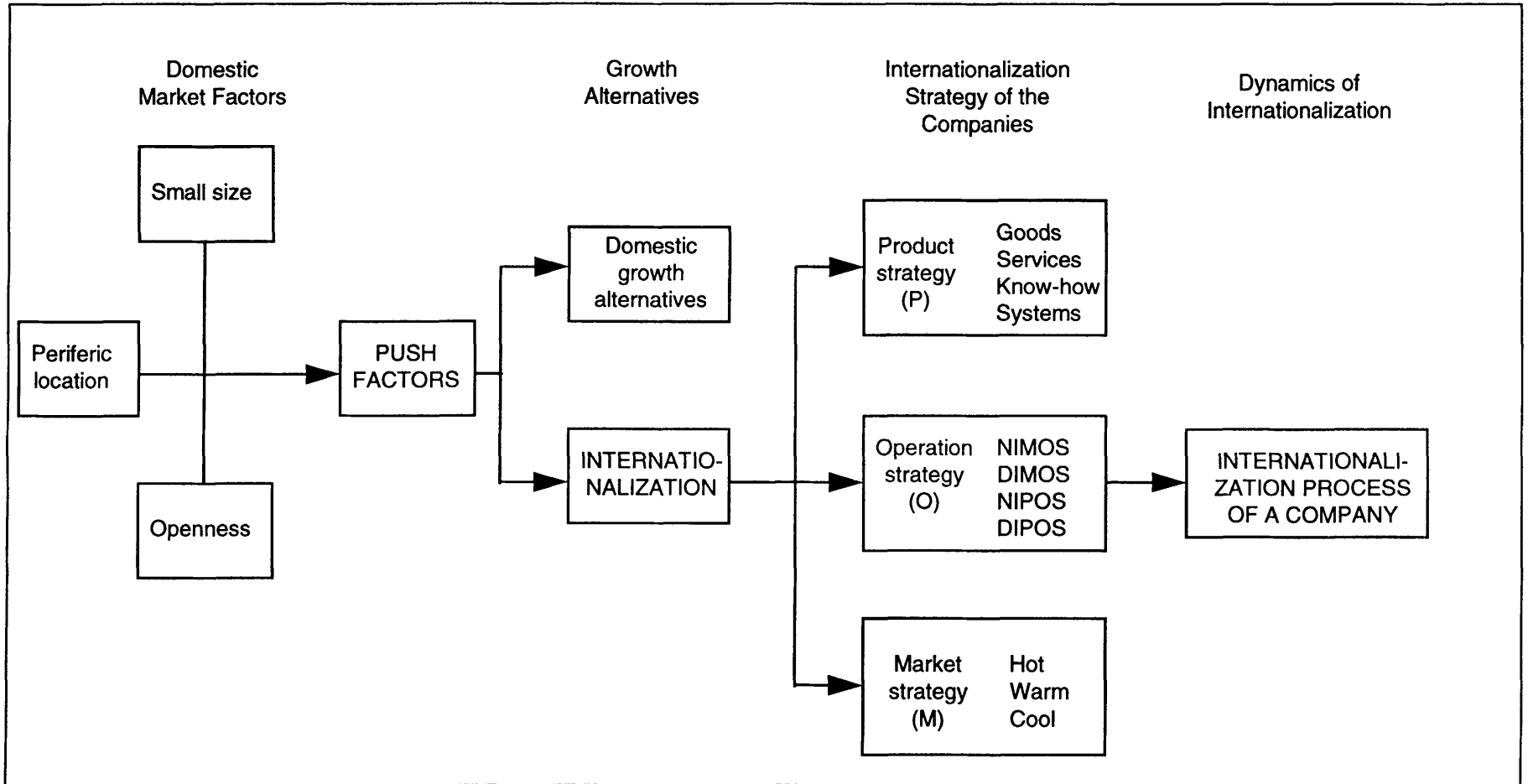

TABLE A1

ORDER OF UTILIZATION OF INWARD, OUTWARD AND COOPERATION MODES OF INTERNATIONAL OPERATIONS IN 586 FINNISH INDUSTRIAL COMPANIES IN 1990

Order of utilization	Small firms		Medium-sized firms		Large firms		All firms	
	Number	%	Number	%	Number	%	Number	%
Inward	-	-	2		-	-	2	0
Inward-outward	109	35	58		22	25	189	32
Inward-outward-coop.	47	15	45		36	40	128	22
Inward-coop.-outward	10	3	3		4	4	17	3
INWARD TOTAL	166	53	108	59	62	69	336	57
Outward	68	22	21		5	6	94	16
Outward-inward	39	12	31		3	3	73	12
Outward-inward-coop.	21	7	9		8	9	38	7
Outward-cooperative	9	3	6		6	7	21	4
Outward-coop.-inward	8	2	7		3	3	18	3
OUTWARD TOTAL	145	46	74	40	25	28	244	42
Cooperative-outward-inward	1	0	-	-	1	1	2	0
Cooperative-inward-outward	-	-	1	1	2	2	3	0
Cooperative-outward	1	0	-	-	-	-	1	0
COOPERATIVE TOTAL	2	1	1	1	3	3	6	1
GRAND TOTAL	313	100	183	100	90	100	586	100

FIGURE A2

COMPONENTS AND SUBCOMPONENTS OF THE LATERALLY RIGID DECISION PROCESS TOWARDS INTERNATIONALIZATION

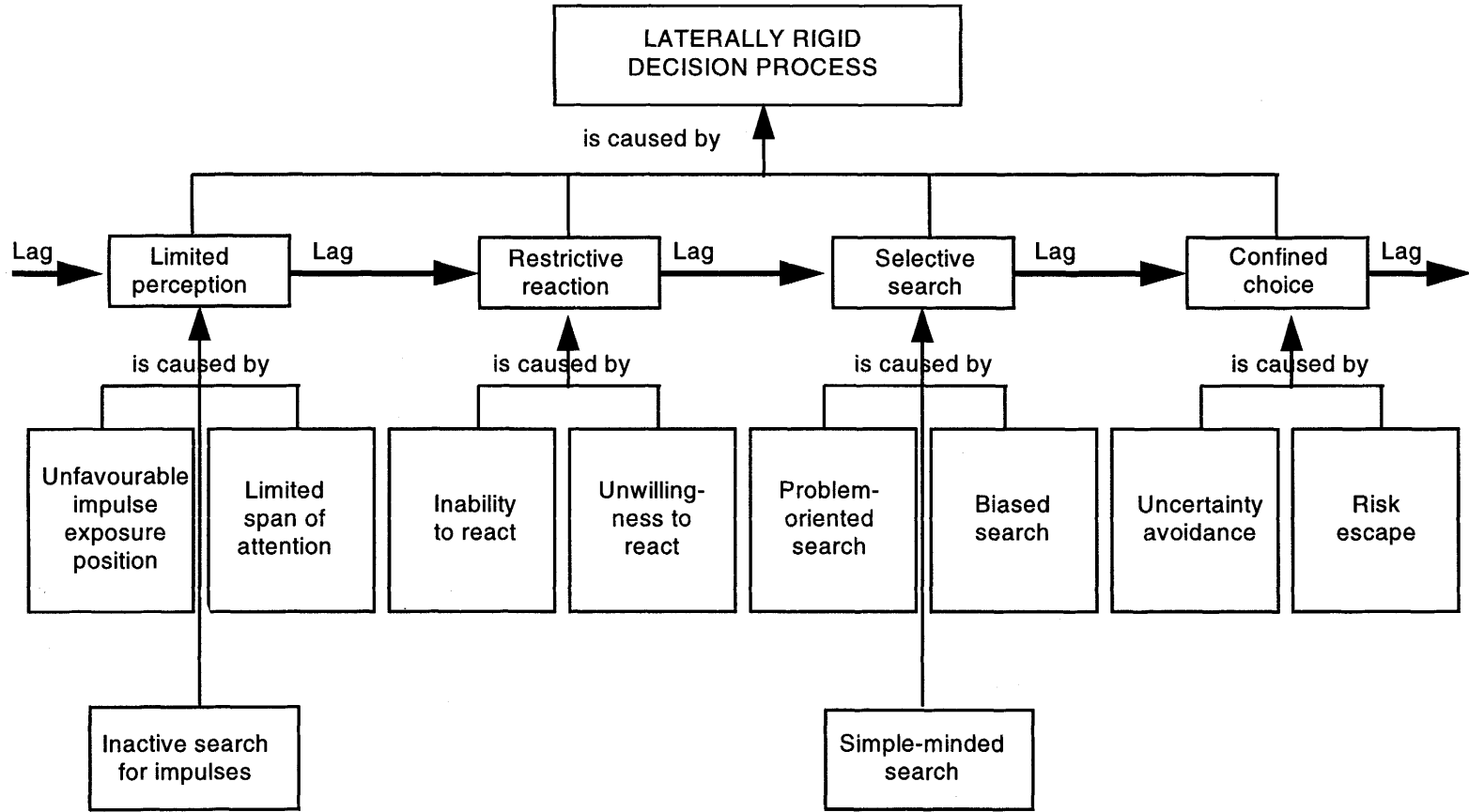

→ = Successive stages in the decision-making process with related time lags.

TABLE A2

CHANGES NEEDED IN THE PLANNING AND PROMOTION OF OUTWARD INTERNATIONAL BUSINESS OPERATIONS

Target	Operative planning/promotion	Strategic planning/ promotion
Traditional export operations	Present focus	Future focus
Other outward operations	Future focus	Future focus

Source: Luostarinen, Korhonen et al. 1994.

TABLE A3

FUTURE DIRECTIONS OF THE PLANNING AND PROMOTIONAL MEASURES FOR INTERNATIONALIZATION

Target	Operative planning/promotion	Strategic planning/promotion
Outward operations	Present focus	Future focus
Inward & cooperative operations	Future focus	Future focus

Source: Luostarinen, Korhonen et al. 1994

TABLE A4

INTERNATIONALIZATION PROMOTION COVERS BOTH INDUSTRIAL AND SERVICE COMPANIES

Target	Industrial companies	Service companies
Outward operations	Present focus	Future focus
Inward & cooperative operations	Future focus	Future focus

Source: Luostarinen, Korhonen et al. 1994

Source: Luostarinen 1991:271; Luostarinen 1993:12;
Luostarinen, Korhonen et al. 1994:314

UNU World Institute for
Development Economics Research
(UNU/WIDER)
Katajanokanlaituri 6 B
00160 Helsinki, Finland

Telephone (358) 0-693841
Telex 123455 UNUEI FI
Facsimile (358) 0-6938548